

CANopen / PROFIBUS DP Gateway

GT200-DP-CO

User Manual

V 5.3

REV B



SST Automation

E-mail: SUPPORT@SSTCOMM.COM

WWW.SSTCOMM.COM



Important Information

Warning

The data and examples in this manual cannot be copied without authorization. SST Automation reserves the right to upgrade the product without notifying users.

The product has many applications. The users must make sure that all operations and results are in accordance with the safety of relevant fields, and the safety includes laws, rules, codes and standards.

Copyright

Copyright © 2021 by SST Automation. All rights reserved.

Trademark



is the registered trade mark of SST Automation.

Technical Support Contact Information

www.sstcomm.com

E-mail: support@sstcomm.com

Catalog

1 Product Overview.....	1
1.1 Product Function.....	1
1.2 Product Feature.....	1
1.2.1 CANopen Acts as Master.....	1
1.2.2 CANopen Acts as Slave.....	1
1.3 Technical Specifications.....	1
1.4 Attention.....	3
1.5 Related Products.....	3
1.6 Revision History.....	4
2 Hardware Descriptions.....	5
2.1 Indicators.....	6
2.2 DIP Switch.....	7
2.3 Communication Interface.....	7
2.3.1 PROFIBUS DP Interface.....	7
2.3.2 CANopen Interface.....	8
2.4 Power Interface.....	8
2.5 LED Display.....	8
2.6 PROFIBUS DP Address Setting Button.....	9
3 Mounting.....	10
3.1 Mechanical Dimension.....	10
3.2 Mounting Method.....	11
4 Quick Start Guide.....	12
4.1 Hardware Wiring.....	12
4.2 Configuration.....	12
5 Software Instructions.....	13
5.1 Notes before Configuration.....	13
5.2 User Interface.....	14
5.3 Acts as CANopen Master.....	16
5.3.1 Device View Operation.....	16
5.3.2 Configuration View Operation.....	17
5.4 Acts as CANopen Slave.....	21
5.4.1 Device View Operation.....	21
5.4.2 Configuration View Operation.....	22
5.5 Hardware Communication.....	25



GT200-DP-CO CANopen/PROFIBUS DP Gateway

User Manual

5.5.1 COM Configuration.....	25
5.5.2 Upload.....	26
5.5.3 Download.....	26
5.6 Load and Save Configuration.....	27
5.6.1 Load Configuration Project.....	27
5.6.2 Save Configuration Project.....	27
5.7 Auto Mapping.....	28
5.8 Export Excel File.....	28
5.9 Monitor.....	29
6 Working Principle.....	31
6.1 Data Exchange.....	31
6.1.1 Data Exchange as CANopen Master.....	31
6.1.2 Data Exchange as CANopen Slave.....	33
6.2 PROFIBUS DP Data Module.....	34
6.2.1 Acts as CANopen Master.....	34
6.2.2 Acts as CANopen Slave.....	35
6.3 How Step7 Reads and Writes Gateway Data.....	38
6.4 How Step7 Selects Data Module.....	39
Appendix: Using STEP7 to Set PROFIBUS DP Communication.....	40

1 Product Overview

1.1 Product Function

CANopen side of GT200-DP-CO can be a master or a slave. When acting as a master, it supports connecting multiple standard devices with CANopen slave interface to PROFIBUS DP network. When acting as a slave, it supports connecting CANopen master device to PROFIBUS DP network.

1.2 Product Feature

1.2.1 CANopen Acts as Master

- Supports one CANopen master interface.
- CANopen interface: 1KV photoelectric isolation.
- Acts as a slave at the side of PROFIBUS DP network, PROFIBUS baud rate is self-adaptive, and up to 12M.
- PROFIBUS input and output bytes can be selected, the maximum number is:

Max Input Bytes+ Max Output Bytes≤488 Bytes.

①Max Input Bytes ≤244 Bytes.

②Max Output Bytes ≤244 Bytes.

1.2.2 CANopen Acts as Slave

- Supports one CANopen slave interface.
- CANopen interface: 1KV photoelectric isolation.
- Acts as a slave at the side of PROFIBUS DP network, PROFIBUS baud rate is self-adaptive, and up to 12M.
- PROFIBUS input and output bytes can be selected, the maximum number is:

Max Input Bytes+ Max Output Bytes≤488 Bytes.

①Max Input Bytes ≤244 Bytes.

②Max Output Bytes ≤244 Bytes.

1.3 Technical Specifications

[1] Communication baud rate:

- ◆ CANopen baud rate: 50kbit/s, 100kbit/s, 125kbit/s, 250kbit/s, 500kbit/s, 1Mbps.
- ◆ PROFIBUS DP baud rate is self-adaptive and can be up to 12M.

[2] CAN: ISO 11898-compatible CAN interface is CAN2.0A type with an 11-bit identification.

[3] DS-301 V4.01 and CiA Draft Recommendation 303 compliant.

CANopen master features:

- ◆ Supports at most 8 bytes of TPDO, 8 bytes of RPDO, fast Download SDO and fast Upload SDO.
- ◆ Every CANopen node has default 4 TPDOs and 4 RPDOs. COB-ID of TPDO and RPDO has default value. Default value of Transmit PDO:

384 + node address (0x180+node address)

640 + node address (0x280+node address)

896 + node address (0x380+node address)

1152 + node address (0x480+node address)

Default value of Receive PDO:

512 + node address (0x200+node address)

768 + node address (0x300+ node address)

1024 + node address (0x400+ node address)

1280 + node address (0x500+node address)

- ◆ Every CANopen node also can have a self-defining COB-ID, but the COB-ID cannot be conflicting with CANopen protocol.
- ◆ Supports maximum commands No. : (84)

Max TPDO commands + Max RPDO commands + Max upload SDO commands + Max download SDO commands ≤ 84.

Max TPDO commands ≤ 84.

Max RPDO commands ≤ 84.

Max upload SDO commands ≤ 84.

Max download SDO commands ≤ 84.

- ◆ Supports NMT management, TPDO time-out reset and SYNC function, besides, it also supports function of PROFIBUS DP controlling CANopen slave devices, etc.
- ◆ Supports connecting slaves with heartbeat and Guard life.
- ◆ Same command can be mapped to different input or output buffer address of PROFIBUS DP.

CANopen slave features:

- ◆ Supports at most 8 bytes of TPDO, 8 bytes of RPDO.
- ◆ Fast Download SDO and fast Upload SDO.
- ◆ Every CANopen node supports up to 42 TPDOs, 42 RPDOs. COB-ID of TPDO and RPDO has default value or users can use self-defining COB-ID.

Default value of Transmit PDO:

384 + node address (0x180+node address)

640 + node address (0x280+node address)

896 + node address (0x380+node address)

1152 + node address (0x480+node address)

Default value of Receive PDO:

512 + node address (0x200+node address)

768 + node address (0x300+ node address)

1024 + node address (0x400+ node address)

1280 + node address (0x500+node address)

- ◆ Support at most 42 TPDO and 42 RPDO.
- ◆ Timeout clear function of RPDO and delay to start-up.
- ◆ Supports SDO visiting input and output data exchange area.
- ◆ Only supports Heartbeat.

- [4] Work circumstance temperature: -4°F ~140°F (-20°C to 60°C), REL Humidity: 5% to 95% (non-condensing).
- [5] Power: 24VDC (11V~30V), maximum 90mA (24V).
- [6] External dimensions size (W*H*D): 0.98 in*3.94 in*3.54 in (25mm*100mm*90mm).
- [7] Installation: 35mm DIN RAIL.

1.4 Attention

- ✧ To prevent stress, prevent module panel damage.
- ✧ To prevent bump, module may damage internal components.
- ✧ Power supply voltage control in the prospectus, within the scope of the requirements to burn module.
- ✧ To prevent water, water module will affect the normal work.
- ✧ Please check the wiring, before any wrong or short circuit.

1.5 Related Products

Related products include:

GT200-DP-CA, GT200-CO-EI and so on.

More information about these products, please visit: www.sstcomm.com



1.6 Revision History

Revision	Date	Chapter	Description
V5.2, REV A	3/3/2016	Chapter 5	First release V5.2 user manual, add function of SDO Send Concurrently, Retries of SDO, SDO Poll Delay Time
V5.3, REV A	21/2/2017	All	First release V5.3, the same with V5.2 REV A
V5.3, REV B	5/21/2020	All	Revision

2 Hardware Descriptions

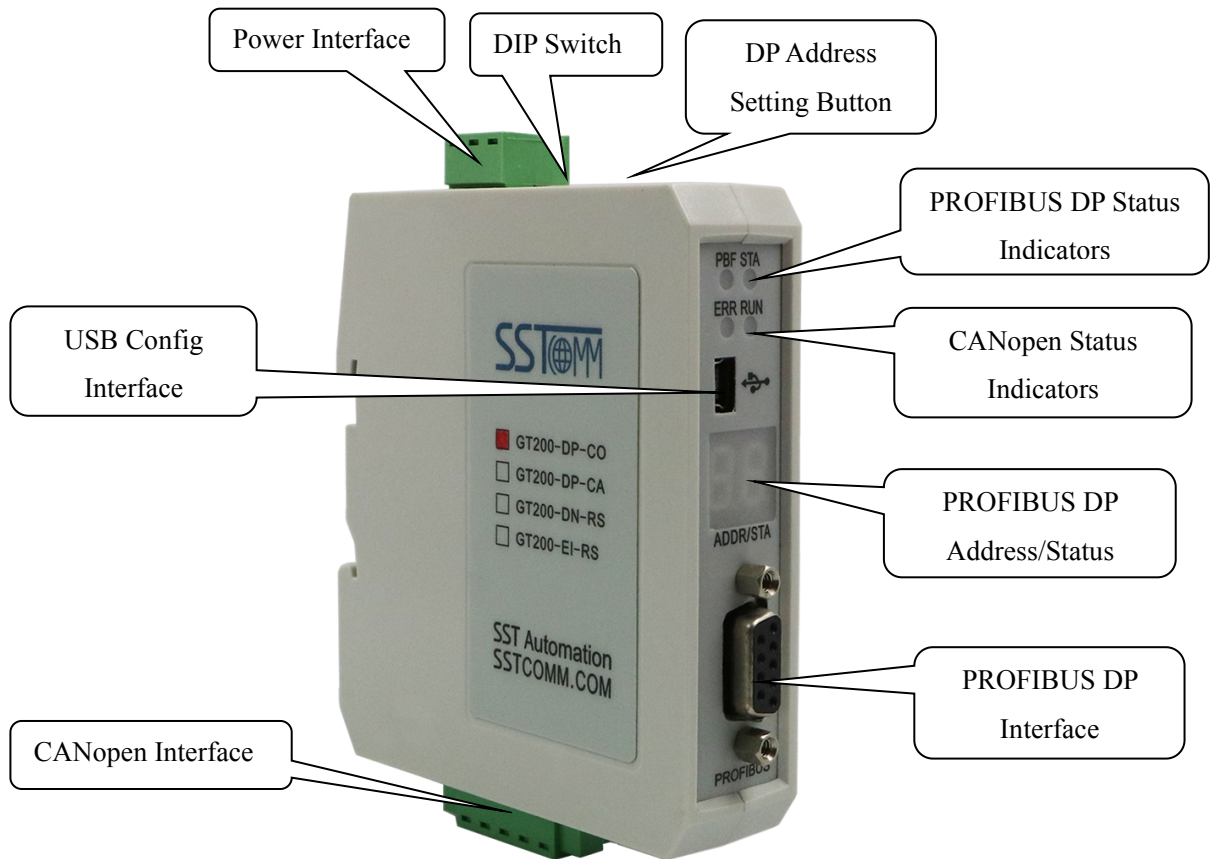

Note: This picture is for reference only. The product appearance is subject to the actual product.

2.1 Indicators

Indicators		Status	Description
PROFIBUS Status	PBF	On	PROFIBUS DP connection has not been established
		Off	PROFIBUS DP connection has been established
	STA	Blinking	Exchanging data
		Off	PROFIBUS DP status is abnormal
CANopen Status	ERR	Green on	The CAN network is normal
		Red on	Bus Off
		Red, Green and Off alternately	The error counter of CAN controller reach or exceed alarm value
	RUN	Green on	Operational state
		Green light on every 200ms, off every 1000ms	Stop state
		Green light on every 200ms, off every 200ms	Pre-operational state

2.2 DIP Switch

Switch Run mode to Configuration mode: Set Bit2 to ON, the gateway will enter Configuration mode (no need to restart the gateway).

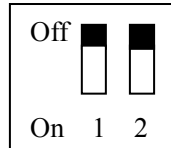

Function (Bit1)	Mode (Bit2)	Description
Off	Off	Run mode, allow setting DP address
Off	On	Configuration mode
On	Off	Run mode with debug function, not allow setting DP address
On	On	Run mode, prohibit setting DP address (Locked)

Notes: Except for the Locked status, no need to restart the gateway to apply the state switching.

2.3 Communication Interface

2.3.1 PROFIBUS DP Interface

PROFIBUS DP interface uses DB9 connector, and the pins are defined as follows:

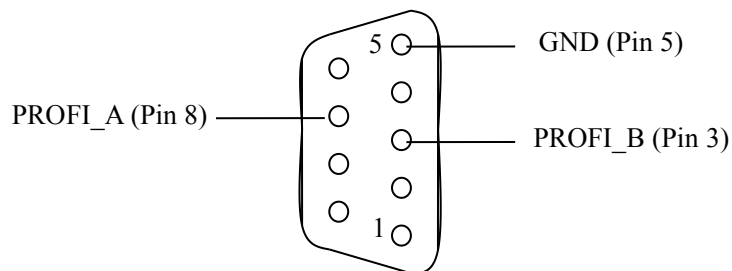

DB9 pin	Description
3	PROFI_B, Data positive
5	GND (optional)
8	PROFI_A, Data negative

2.3.2 CANopen Interface

Open five-pin interface at the side of CAN:

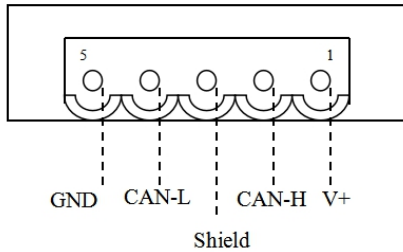

Pin	Description
1	V+ (Optional)
2	CAN-H
3	Shield (Optional)
4	CAN-L
5	GND

Note 1: Connections of V+ and shield are optional, but connections of CAN-H, CAN-L and GND are necessary.

Note 2: V+, GND of CANopen interface interlinks 24V+, GND of power interface internally. You only need to power on one of the two interfaces. Powering on this two interfaces is not allowed.

2.4 Power Interface

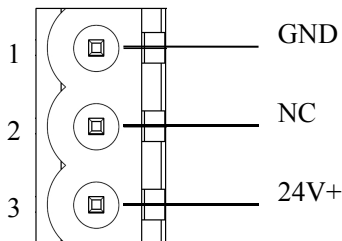

Pin	Description
1	Power ground
2	Not connected
3	24V+, DC

Note 1: 24V+, GND of power interface interlinks V+, GND of CANopen interface. You only need to power on one of the two interfaces. Powering on this two interfaces is not allowed.

2.5 LED Display

In the configuration mode, LED display “CF”.

In the debug mode, LED displays “db”.

In the run mode, LED displays the PROFIBUS DP slave address of the gateway.

2.6 PROFIBUS DP Address Setting Button

The configuration button on the panel can set the PROFIBUS DP slave address.

In run mode of GT200-DP-CO, LED display is always on and displaying the current PROFIBUS DP address. Quickly press (double-click) the button twice in succession, the high bit starts to flash, and the low bit is always on, click the button to add 1 to start setting the high bit of PROFIBUS DP address. Long-press the button for 3 seconds, the high bit is always on, and the low bit starts to flash. Click the button to add 1 to start setting the low bit of PROFIBUS DP address. At last, long-press the button again for 3 seconds, the address flashing three times shows that the address is set successfully. If no button action within ten seconds, the gateway exits the status of setting address and continues to display the original address. The configurable range of PROFIBUS DP address is 0 to 99 (Decimal).

PROFIBUS DP address setting method is as follow:

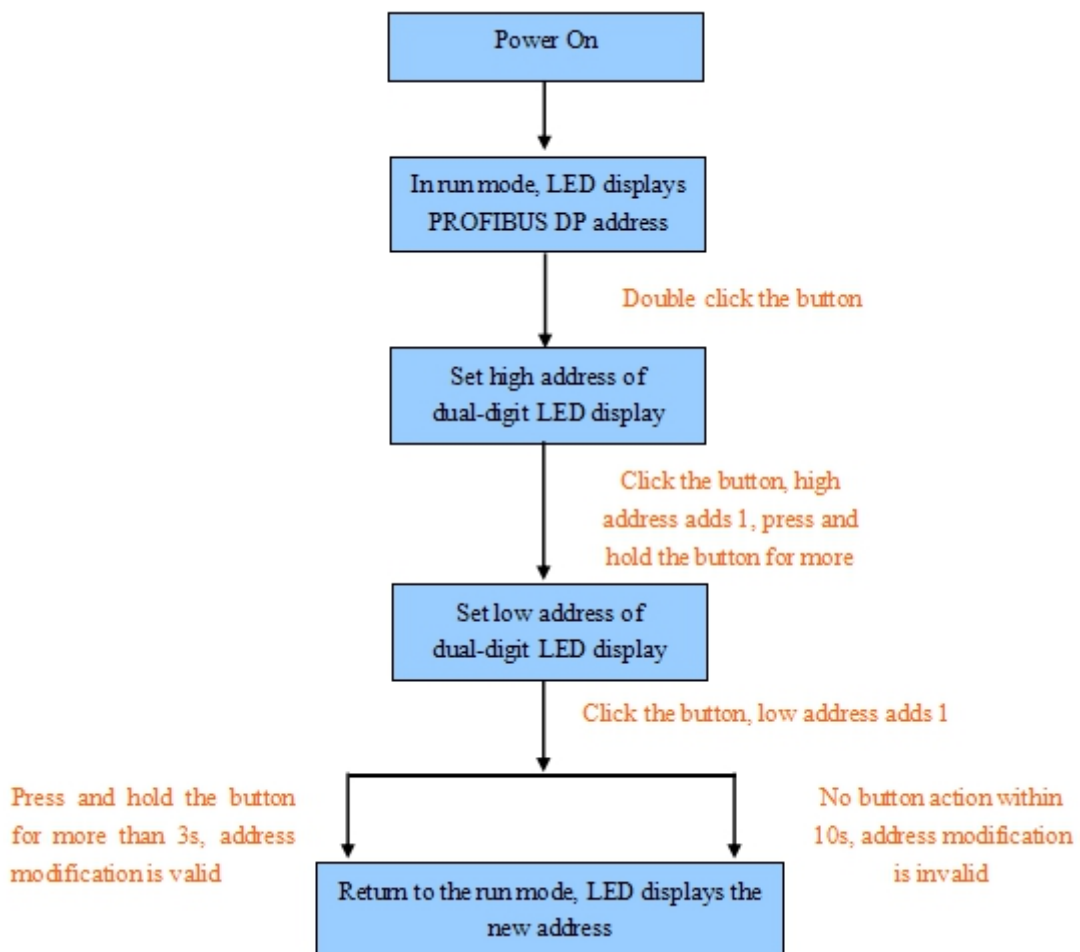

3 Mounting

3.1 Mechanical Dimension

Dimension: 0.98 in (width)*3.94 in (height)*3.54 in (depth)

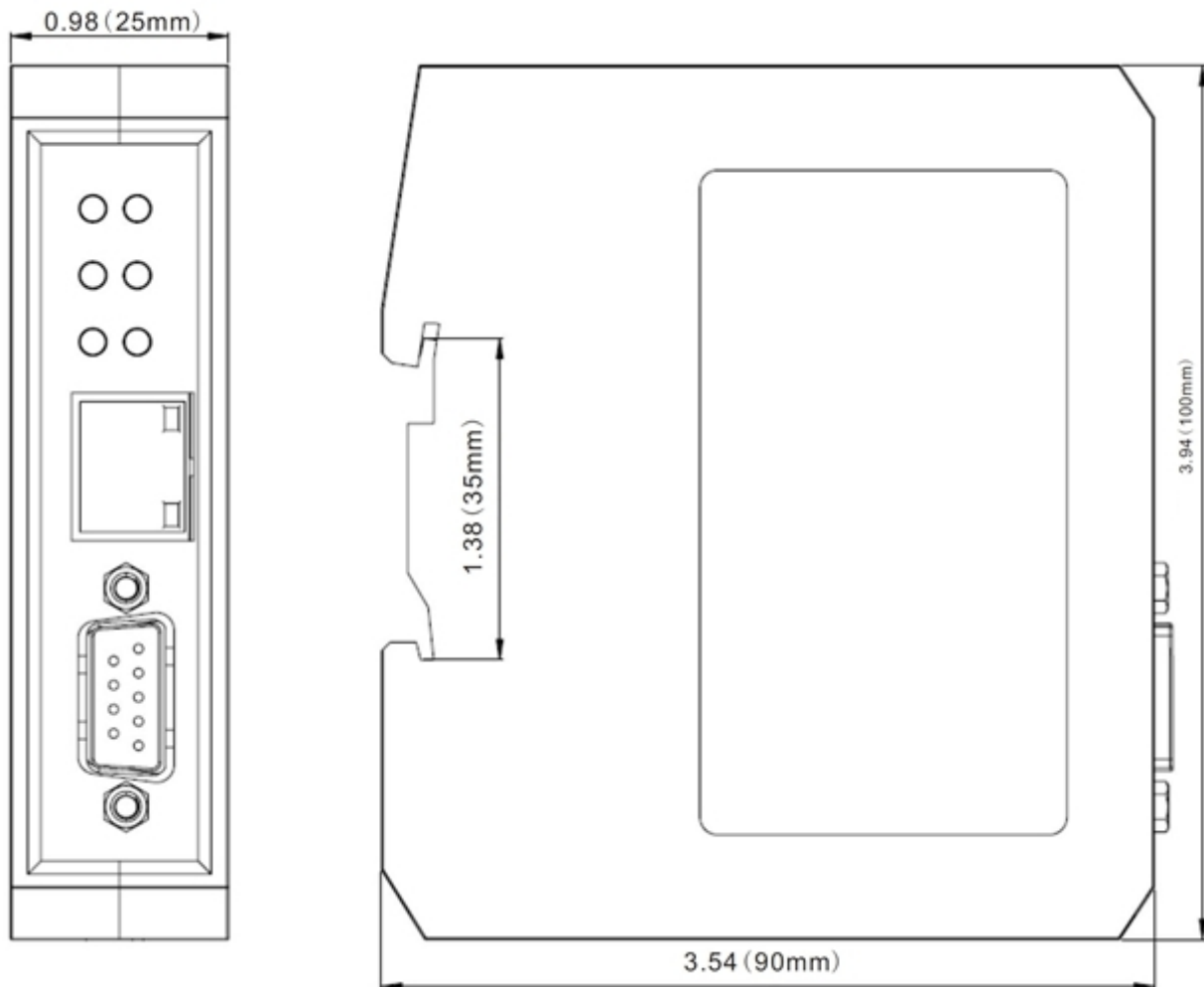

3.2 Mounting Method

Using 1.38 in (35mm) DIN RAIL

Installing the gateway

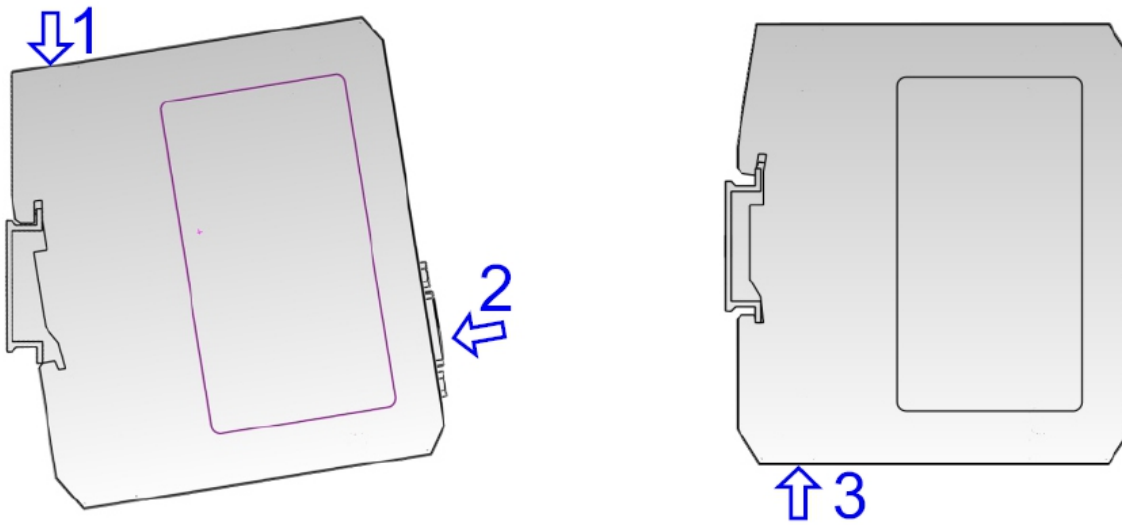

Unloading the gateway

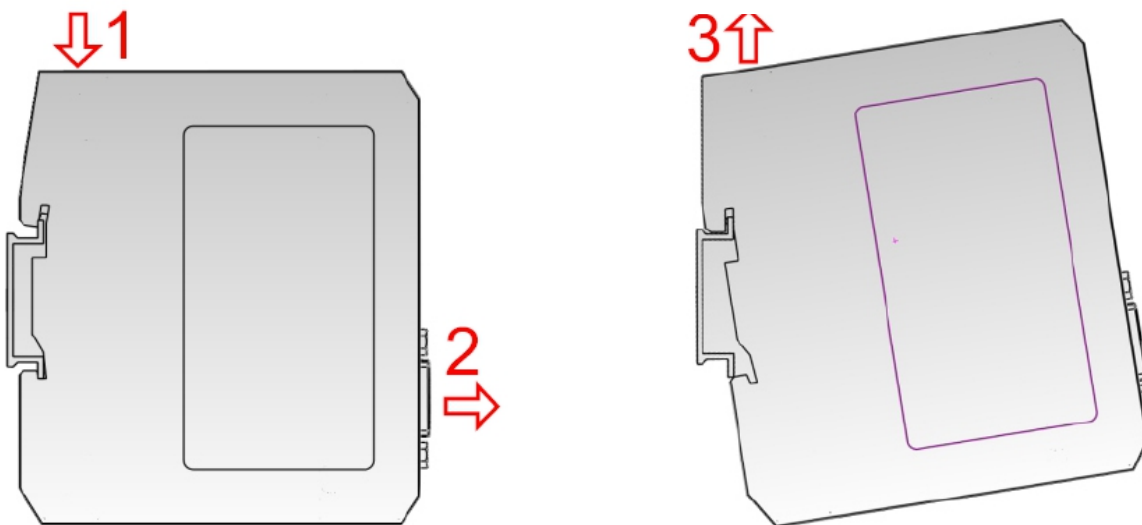

4 Quick Start Guide

4.1 Hardware Wiring

1. According to the PROFIBUS port instructions, properly connect with DB9. It is suggested to use standard PROFIBUS DP connector.
2. According to the CAN port instructions, properly connect the pin 2 and 4 at least.
3. Check all connections whether they comply with the instructions.
4. Set "mode" bit of DIP switch to "Off", power on the module, and the module go into operational state.

4.2 Configuration

1. This gateway has two modes: configuration mode and run mode, you can select different mode through DIP switch. Set "mode" bit of DIP switch to "on", the gateway is in the configuration mode, and turn off the "mode" bit, the gateway is in the run mode.
2. Use USB cable to connect to the USB port of PC and set "mode" bit of DIP switch to "on", then power on the device.
3. In the configuration mode, set CANopen baud rate, CANopen node ID, SDO commands (CANopen master mode), PDO commands and data mapping between CANopen and PROFIBUS DP through gateway configuration software SST-CP-CFG. (See chapter 4.3 for details).
4. Set "mode" bit of DIP switch to "off" state, configure PROFIBUS DP address through DP address setting button, power on again and the module go into run mode.
5. Set the address of the PROFIBUS DP by pressing the button, note that this address must be the same as the address of this slave in the DP master configuration. otherwise DP connection will be failed.
6. In run mode, users can debug data in input and output buffer through setting "function" bit of DIP switch to "ON" status. Users can see the data in debug interface of SST-CP-CFG through USB interface. Users can use the function at the beginning of network communication, when the network is OK, please close the debug function, that is to set "function" bit of DIP switch to "off".

5 Software Instructions

Users can connect GT200-DP-CO to the PC with USB port and configure gateway's relevant parameters through SST-CP-CFG, including CANopen address, CAN baud rate and input/output data mapping bytes number from CANopen network to PROFIBUS.

Configuring steps:

5.1 Notes before Configuration

SST-CP-CFG is based on Windows platform. It is used to configure parameters and commands of GT200-DP-CO. Double-click the icon of the software, and you can see the "Protocols Type Selection" interface of the software:



Select one protocol and you can see the main interface of the software:

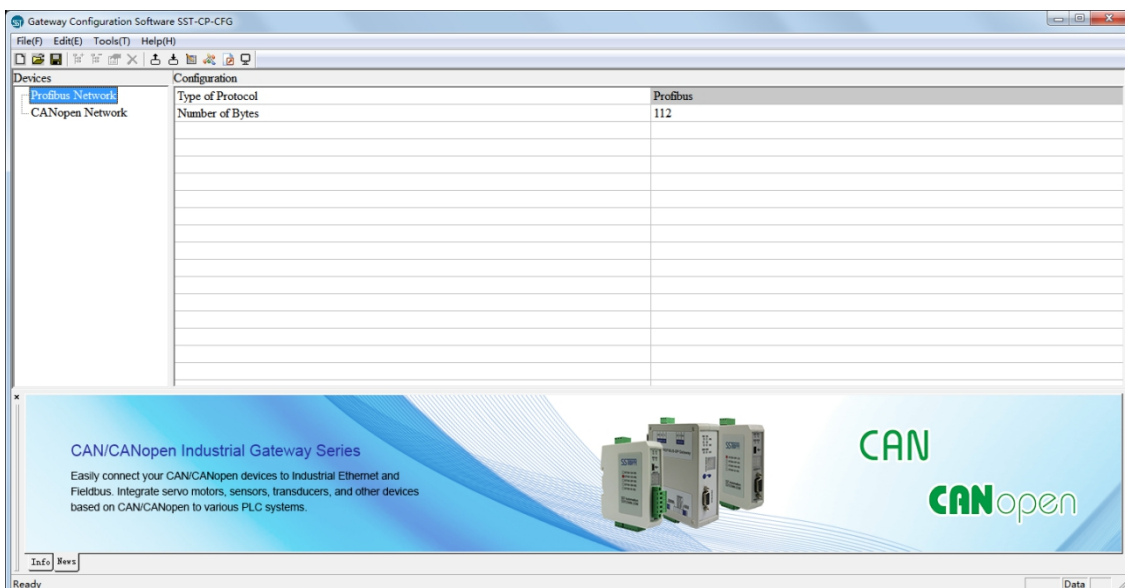

GT200-DP-CO CANopen/PROFIBUS DP Gateway User Manual

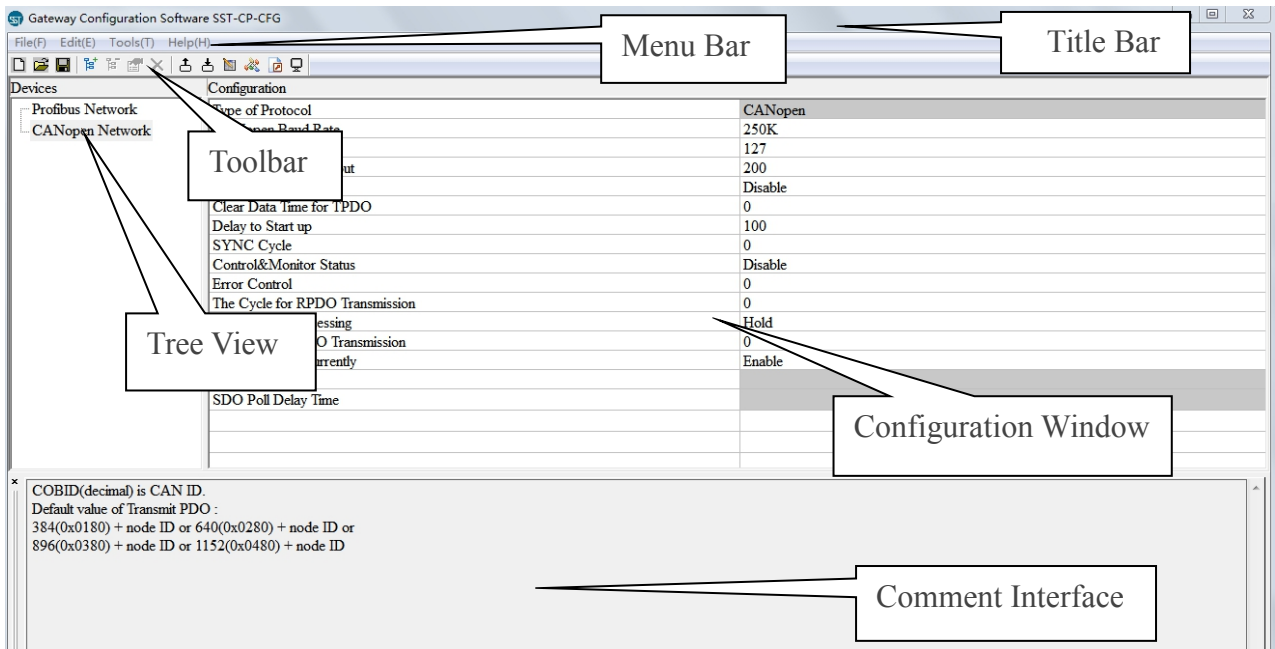

5.2 User Interface

The main interface includes: Title bar, Menu bar, Toolbar, Status bar, Tree View, Configuration Interface and Comment Interface.

Note: All the gray sections in the software cannot be changed.

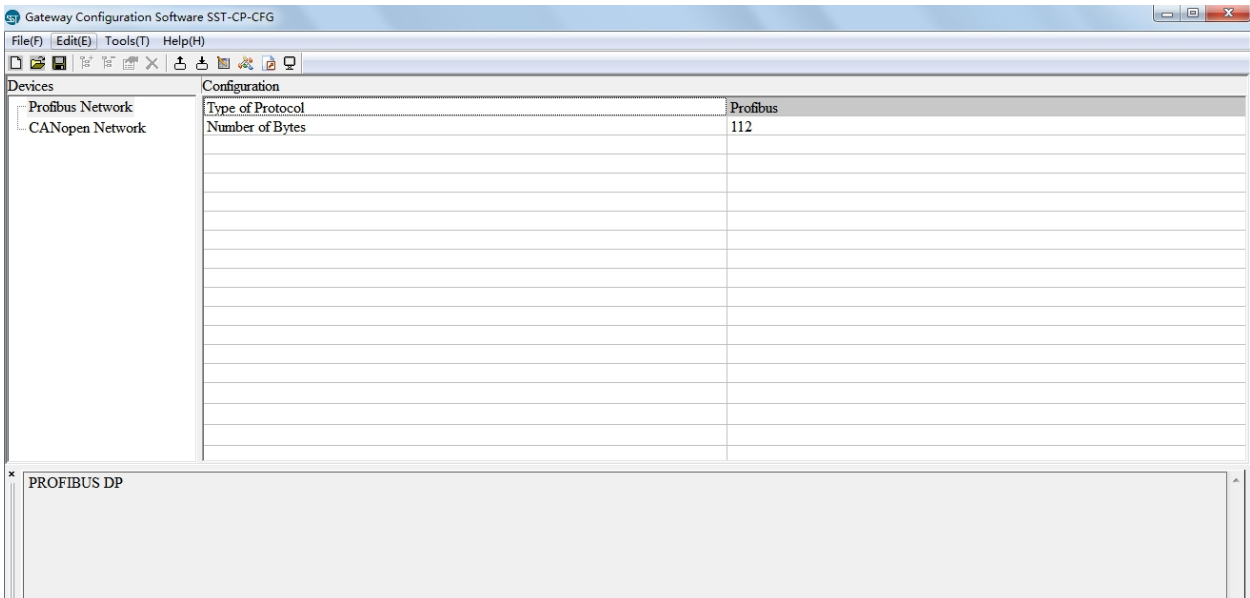



Toolbar:

Toolbar is shown as below:





The function of Toolbar: New, Open, Save, Add Node, Delete Node, Add Command, Delete Command, Upload, Download, Calculate Mapping Address, Mapping Address Conflict Detection, Export EXCEL and Monitor.

 New: Create a new configuration project.

 Open: Open a configuration project.

 Save: Save current configuration.

 Add Node: Add a node for CANopen master.

 Delete Node: Delete a node for CANopen master.

 Add Command: Add a CANopen command.

 Delete Command: Delete a CANopen command.

 Upload: Read the configuration information from the module and shown in the software.

 Download: Download the configuration file to the gateway.

 Calculate Mapping Address: Used to automatically calculate the mapped memory address without conflict by each command.

 Mapping Address Conflict Detection: To check whether there are some conflicts with configured commands in the gateway memory data buffer.

 Export EXCEL: Export current configuration to the local hard disk, saved as .xls file.

 Monitor: Monitor the gateway memory buffer data.

5.3 Acts as CANopen Master

5.3.1 Device View Operation

5.3.1.1 Device View Interface

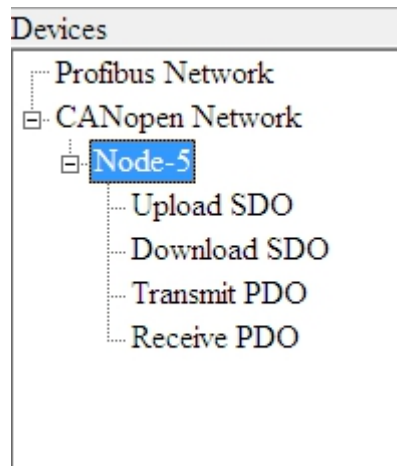

5.3.1.2 Operation Mode

Support three kinds of operation modes: edit menu, edit toolbar, and right-click edit menu.

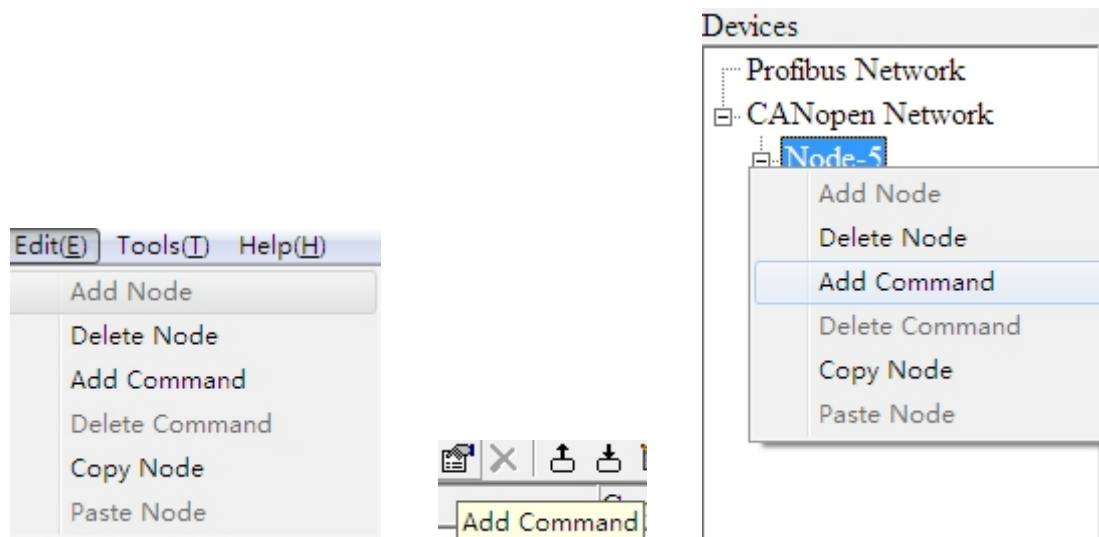

5.3.1.3 Operation Types

- 1) Add node: Left click on CANopen Network or existing nodes, and then perform the operation of adding a new node. Then there is a new node named "New node" under CANopen Network.
- 2) Delete node: Left click on the node to be deleted, and then perform the operation of deleting node. The node

and all commands will be deleted.

3) Add commands: Left click on the node, and then perform the operation of adding command to add a command for the node. It will pop up the command selecting dialog box for users to choose. Shown as below:

Commands: Upload SDO->Profibus In, Download SDO <-Profibus Out, Transmit PDO->Profibus In, Receive PDO<-Profibus Out.

Select commands: Double click a command (Take command selection under CANopen master mode as an example).

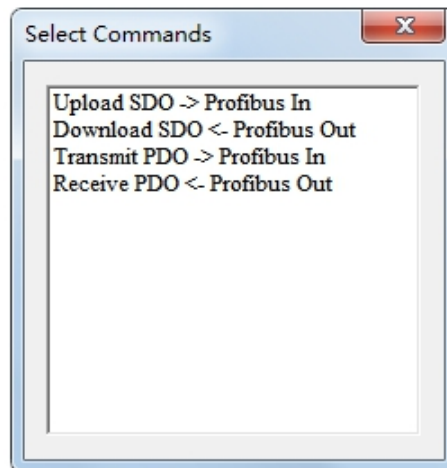

4) Delete command: Left click a command and you can delete it.

5) Copy node: Left click on the existing node, choose the node and execute the operation of copying nodes (include all commands under the node).

6) Paste node: Left click and choose any existing node, execute operation of pasting node. Then under the Modbus TCP tree you can see a new node (include all commands under the node). Parameters of new node is default setting, it needs to be reset.

5.3.2 Configuration View Operation

5.3.2.1 Profibus Network Configuration

Left click the Profibus network in tree view and you can see configuration interface of Profibus network:

Configurable items:

Number of Bytes: 112, 96, 48, 16 can be selected, and the default is 112.

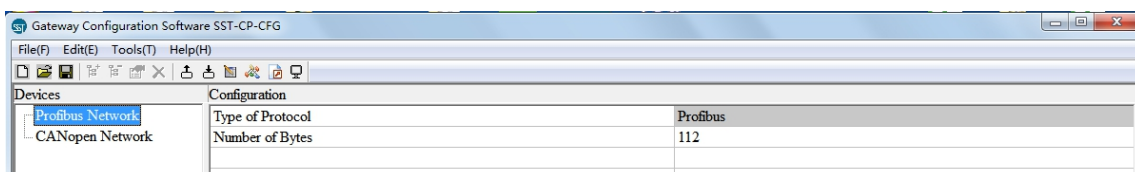

5.3.2.2 CANopen Network Configuration

Configurable parameters are shown as below:

CANopen Baud Rate, CANopen Node ID, SDO Response Timeout, Enable NMT, Clear Data Time for TPDO, Delay to Start up, SYNC Cycle, Control& Monitor Status, etc.

CANopen configuration interface is shown as below:

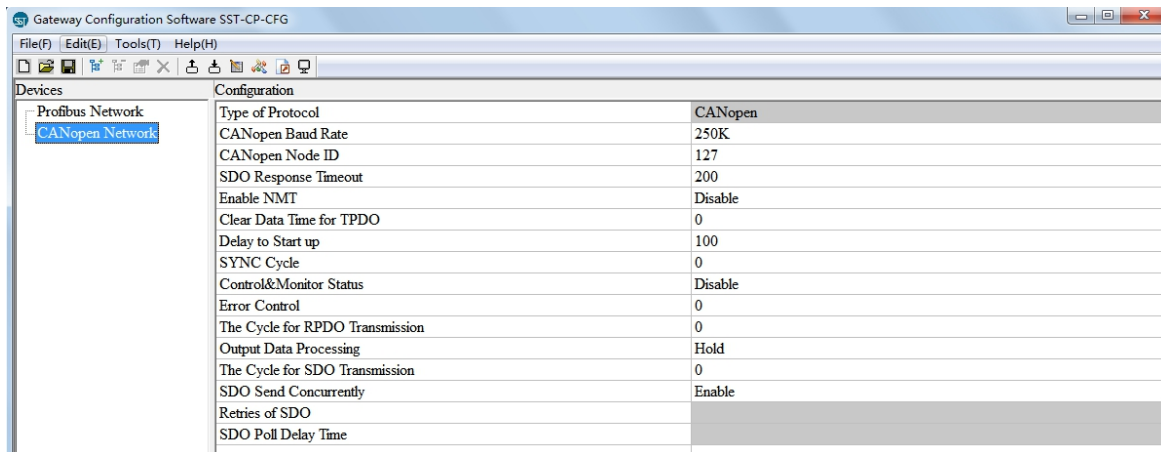

CANopen Baud Rate: 50K, 100K, 125K, 250K, 500K, 1M can be selected. the default value is 250K.

CANopen Node ID: 1 to 127, the default value is 1.

SDO Response Timeout: This parameter is based on 10 milliseconds. The range of the parameter value is 1 to 2000. Default value is 200.

Enable NMT: Whether to start all CANopen nodes on the network or not, the default is disable

Clear Data Time for TPDO: TPDO timeout value

0: Do not use the function.

Nonzero value: Use timeout function and the timeout value is nonzero integral multiple of 10 milliseconds, the range is 0 to 2000, the default is 0

Delay to start up: Delay value

0: Do not use the function.

Nonzero value: Use the function, and delay value is nonzero integral multiple of 10 milliseconds, the range is 0 to 2000, the default is 100. When the value of "Enable NMT" is "Enable", the parameter is valid.

SYNC Cycle: Synchronizing cycle

0: Do not use synchronizing cycle function

Nonzero value: Use the function, and the synchronizing cycle is nonzero integral multiple of 10 milliseconds, the range is 1 to 2000, the default is 0

Control& Monitor Status: The first two bytes of output buffer is used as status byte of CANopen slave. The first byte of this two byte is address of CANopen slave, and the second byte is the command which controls CANopen slave. Selecting "Enable", SST-CP-CFG will minus two bytes when calculating mapping address automatically and this two byte are saved in the end of buffer.

Error Control: Function selection item. Non-zero means to use life guard protocol. Zero means to use heartbeat protocol. The default is 0. The range is 0~2000.

The Cycle for RPDO Transmission: The Cycle for RPDO Transmission is based on 1ms. Zero means to use the mode of change of value output. Non-zero means to send all RPDO according to the cycle. Sending cycle equals setting value, the default value is 0. The range: 0~60000.

Output Data Processing: When PROFIBUS DP is off, the RPDO data of DP output buffer will Clear and Hold. "Clear" means to set the data to zero. "Hold" means to keep the data unchanged before DP is off.

The Cycle for SDO Transmission: The Cycle for SDO Transmission, is based on 1ms. Zero means Download SDO uses mode of change of value output, Upload SDO uses the mode of non-stop reading slave data. Non-zero means to send all SDO according to the cycle. Sending cycle equals setting value, the default value is 0. The range: 0~60000.

SDO Send Concurrently: Disable: The SDO request for a node must wait for the node's response before initiating the next SDO request. Enable: Sending SDOs command requests of different nodes concurrently.

Retries of SDO: The CANopen master sends an SDO request command but does not receive a response from the slave, and the master repeatedly sends this SDO request command. Range: 0~5, default: 0

SDO Poll Delay Time: The CANopen master sends the SDO request command and receives the response from the slave. The master needs to delay for a while before sending the next SDO request command. This period of time is the SDO command polling delay time. Unit: ms, Range: 0~60000ms, default: 0ms.

5.3.2.3 Node Configuration

In the tree view, left click on a node and then the configuration interface is shown as below:

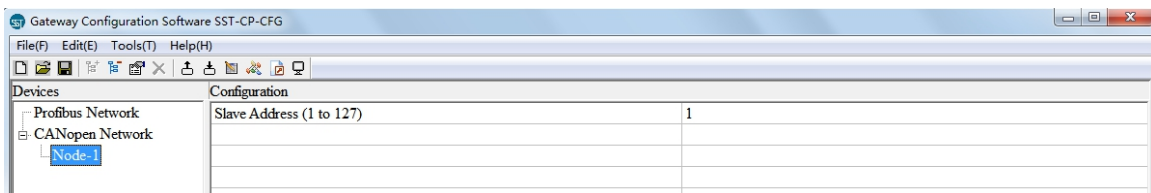

5.3.2.4 Command Configuration

In the tree view, left click on a command and then the configuration interface is shown as below:

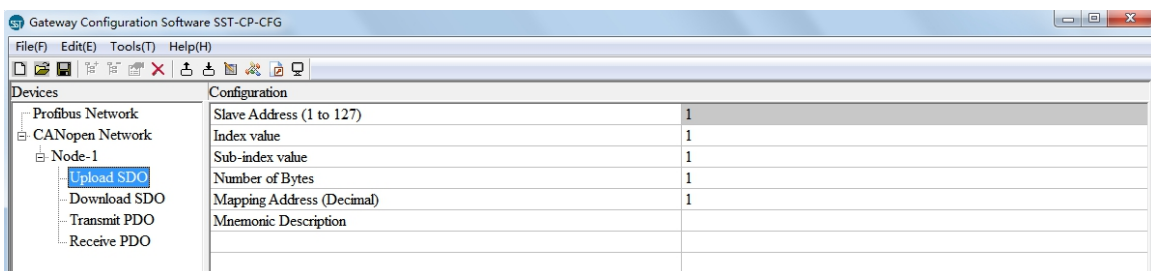

Slave address: CANopen slave address, the range is 1 to127.



Index value: Object index value in object dictionary (decimal).

Sub-index value: Object sub-index value in object dictionary (decimal).

Number of bytes: Number of bytes of mapping item.

Mapping address: Memory address mapped in the gateway (Read only).

COB-ID: The CAN ID (decimal) of CANopen PDO:

Default value of Transmit PDO command: 384(0x180) + node ID or 640(0x280) + node ID or 896 (0x380) + node ID or 1152(0x480) + node ID.

Default value of Receive PDO: 512(0x200) + node ID or 768(0x300) + node ID or 1024 (0x400) + node ID or 1280 (0x500) + node ID.

Mnemonic Description: Users can input the description of project configuration items here. these are not downloaded to gateway actually.

5.3.2.5 Comment Interface

Comment interface displays the explanation of relevant configuration item. When the configuration item is "COB-ID", the comment interface is shown as below:

COBID(decimal) is CAN ID.
Default value of Transmit PDO :
384(0x0180) + node ID or 640(0x0280) + node ID or
896(0x0380) + node ID or 1152(0x0480) + node ID

5.4 Acts as CANopen Slave

5.4.1 Device View Operation

5.4.1.1 Device View Interface

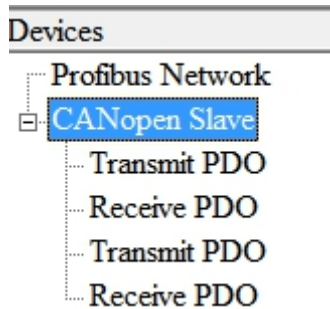

5.4.1.2 Operation Mode

Support three kinds of operation modes: edit menu, edit toolbar, and right-click edit menu.

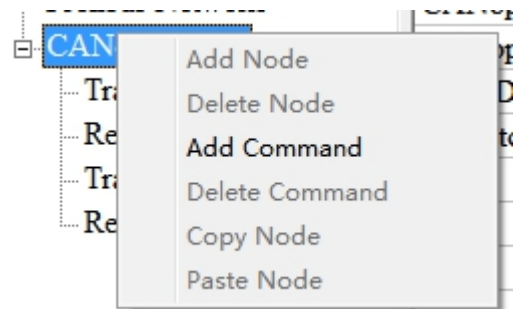
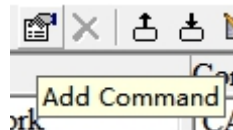
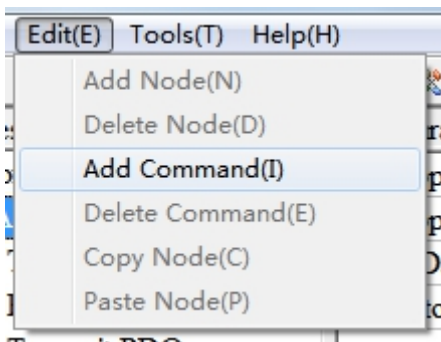

5.4.1.3 Operation Types

- 1) Add node: Left click on CANopen Network or existing nodes, and then perform the operation of adding a new node. Then there is a new node named "New node" under CANopen Network.
- 2) Delete node: Left click on the node to be deleted, and then perform the operation of deleting node. The node and all commands will be deleted.
- 3) Add commands: Left click on the node, and then perform the operation of adding command to add a command for the node. It will pop up the command selecting dialog box for users to choose. Shown as below:
 Commands: Transmit PDO<-Profibus Out, Receive PDO->Profibus In.
 Select commands: Double click a command.

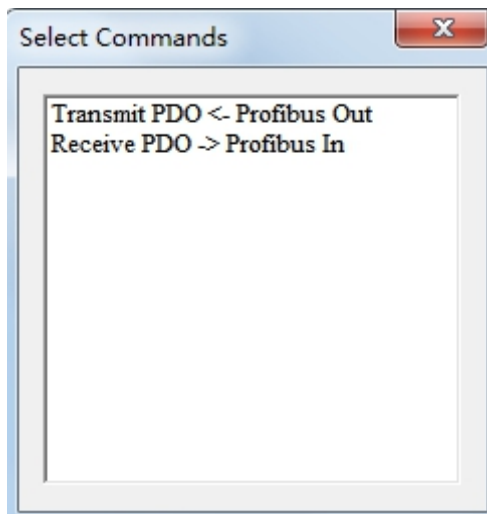

4) Delete commands: Left-click a command and you can delete it.

5.4.2 Configuration View Operation

5.4.2.1 PROFIBUS Configuration

Left click Profibus network in tree view, and you can see configuration section of fieldbus:

Items: Protocol type, Profibus input and output bytes

Protocol type: Profibus

Profibus input and output bytes: 112, 96, 48, 16 can be selected, and the default is 112.

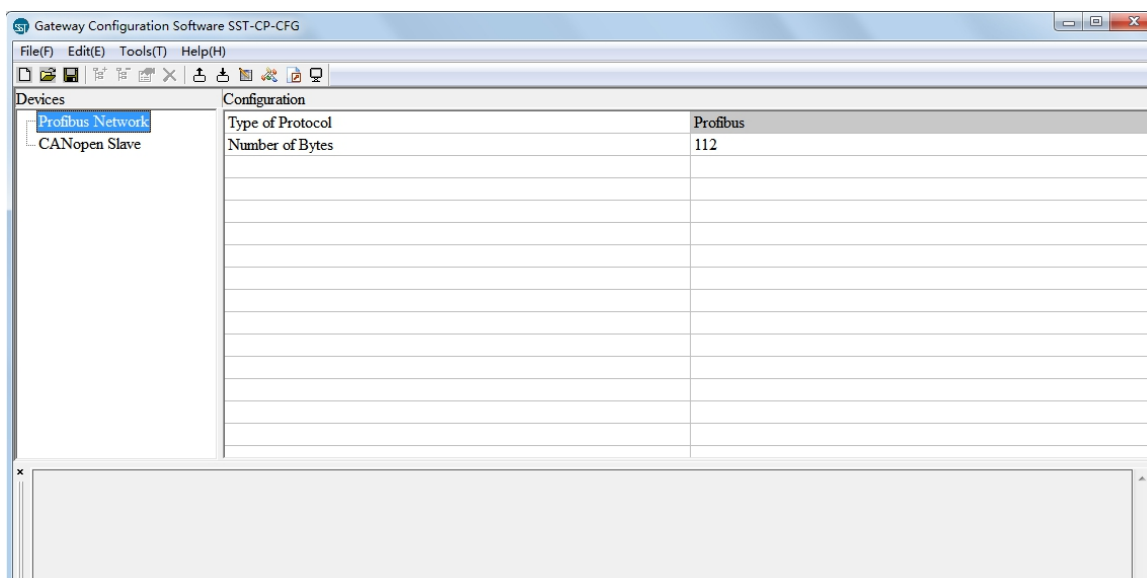

5.4.2.2 CANopen Network Configuration

Configurable parameters are shown as below:

GT200-DP-CO CANopen/PROFIBUS DP Gateway User Manual

CANopen Baud Rate, CANopen Node ID, Clear Data Time for RPDO and Delay to Start up.

CANopen configuration interface is shown as below:

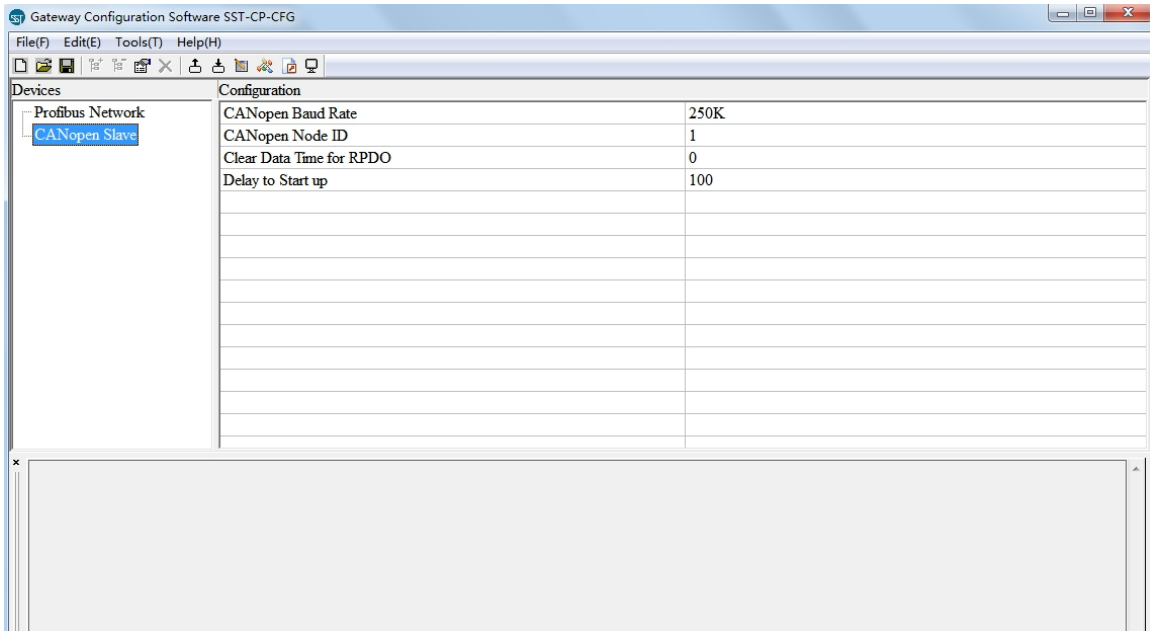

CANopen Baud Rate: 50K, 100K, 125K, 250K, 500K and 1Mbps optional, default value is 250K.

CANopen Node ID: 1 to 127, the default value is 1

Clear Data Time for RPDO: RPDO timeout value

0: Do not use the function.

Nonzero value: Use timeout function and the timeout value is nonzero integral multiple of 10 milliseconds, the range is 0 to 200, the default is 0

Delay to Start up: Delay value

0: Do not use the function.

Nonzero value: Use the function, and delay value is nonzero integral multiple of 10 milliseconds, the range is 0 to 2000, the default is 100. When the value of "Enable NMT" is "Enable", the parameter is valid.

5.4.2.3 Command Configuration

In the tree view, left click on a command and then the configuration interface is shown as below:

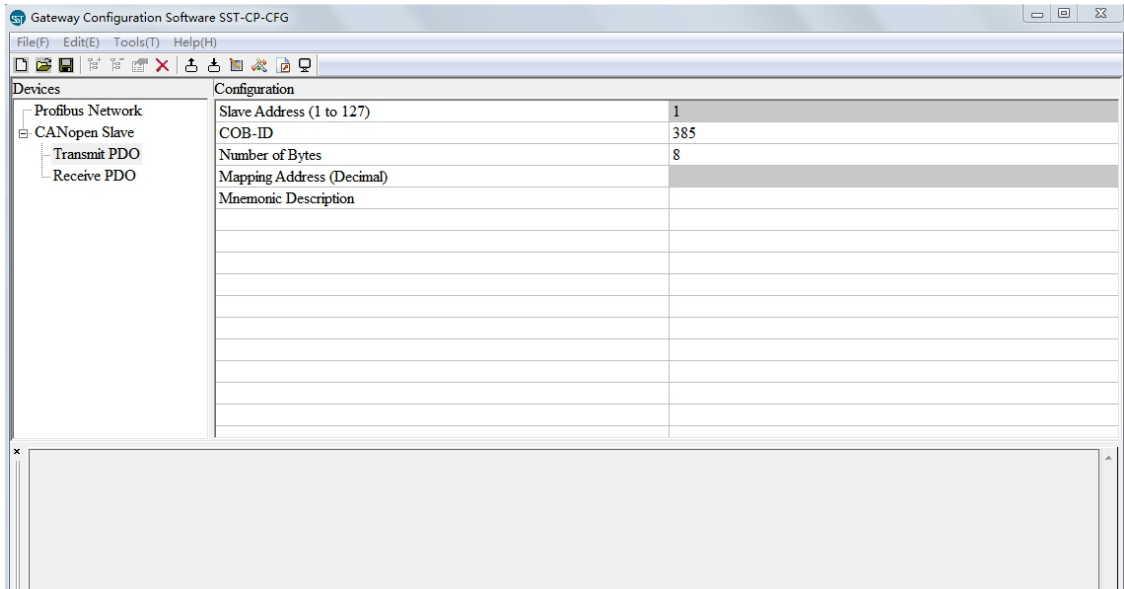

Slave Address: CANopen slave address, the range is 1 to 127.

COB-ID: The CAN ID (decimal) of CANopen PDO:

Default value of Transmit PDO command: 384(0x180) + node ID or 640(0x280) + node ID or 896 (0x380) + node ID or 1152(0x480) + node ID.

Default value of Receive PDO: 512(0x200) + node ID or 768(0x300) + node ID or 1024 (0x400) + node ID or 1280 (0x500) + node ID.

Number of Bytes: The range of the parameter value is 1~8.

Mapping address: Memory address mapped in the gateway (Read only).

Mnemonic description: Users can input the description of project configuration items here. these are not downloaded to gateway actually.

5.4.2.4 Comment Interface

Comment interface displays the explanation of relevant configuration item. When the configuration item is "COB-ID", the comment interface is shown as below:

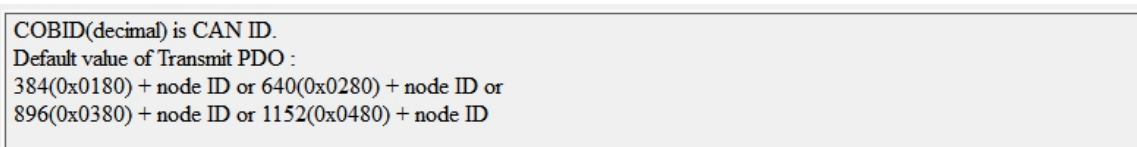

5.5 Hardware Communication

Communication menu is shown as follow:

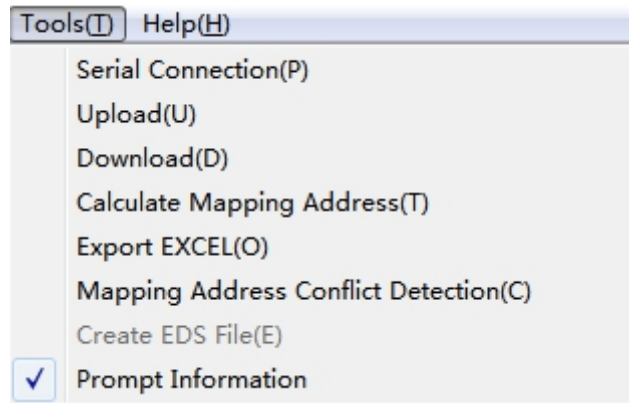

5.5.1 COM Configuration

The software can scan usable serial port automatically, and show it in the port list. Finish all configurations, click "OK" and save settings.

Remark: When you finish setting port, and other parameters are fixed value: 57600, 8, ODD, 8, 1

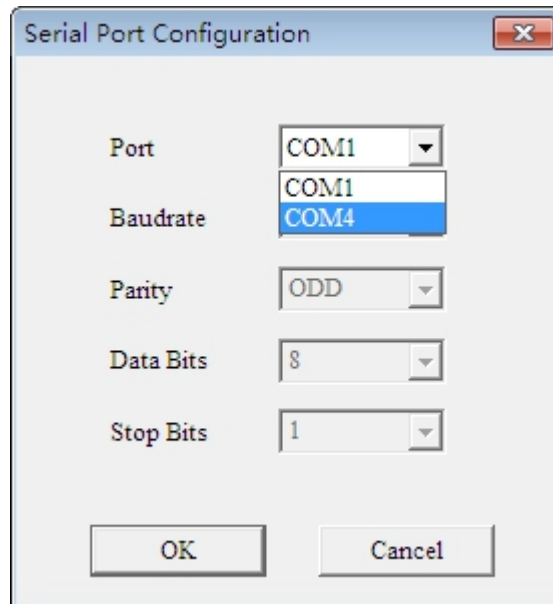

5.5.2 Upload

Select "Upload", it will read configurations from the gateway, and the interface is shown as below:

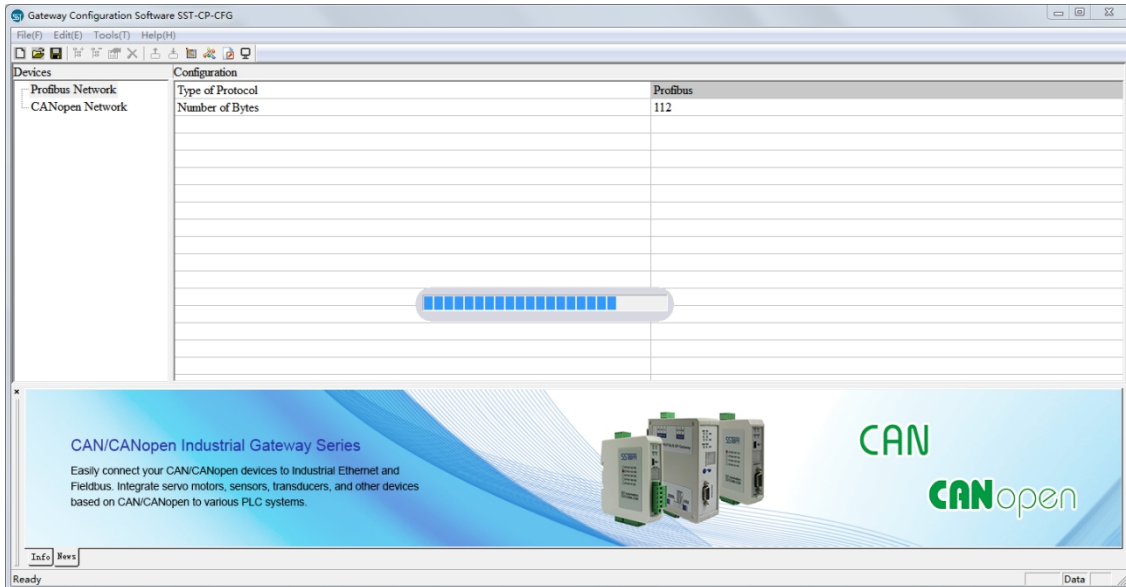

5.5.3 Download

Select "Download", it will download configurations to the gateway, and the interface is shown as below:

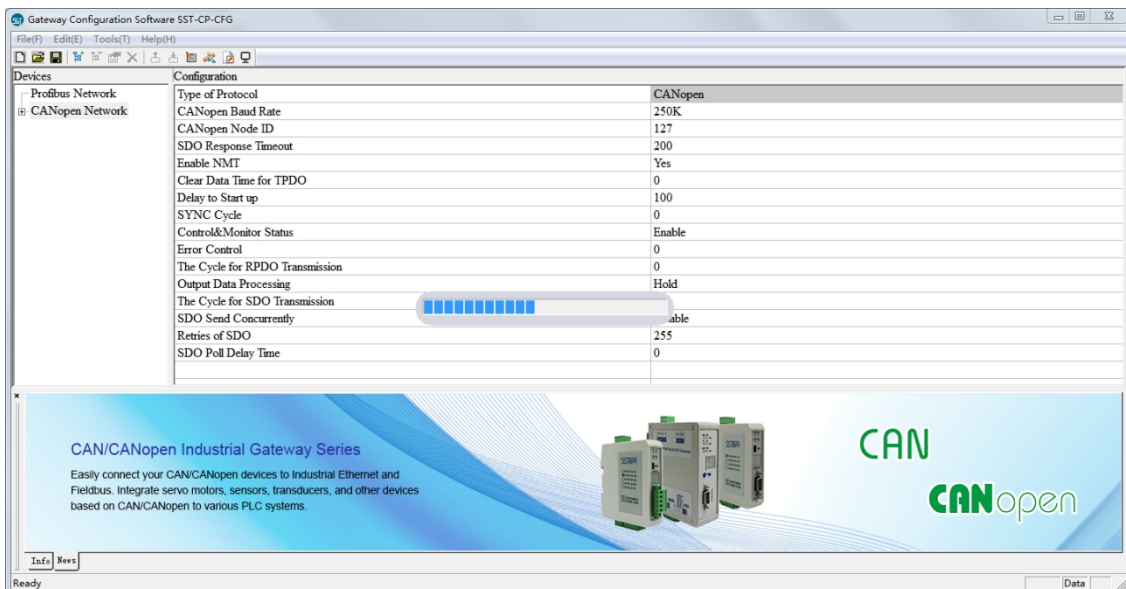

Remark1: Please confirm the port in "COM Config" is the port that you are using before downloading the configurations.

Remark2: Please confirm the configurations are correct before downloading configurations (you can use "Export EXCEL" function and it can help you check the configurations).

5.6 Load and Save Configuration

5.6.1 Load Configuration Project

Select "Open", you can open the configuration project that you have saved.

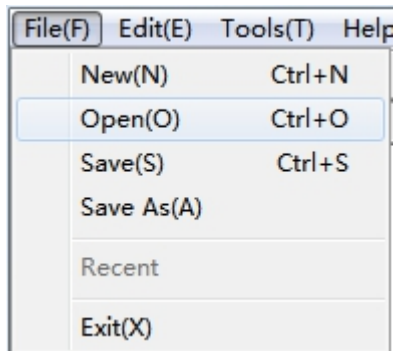

5.6.2 Save Configuration Project

Select "Save" or "Save As", you can save the configuration project with chg as its extension.

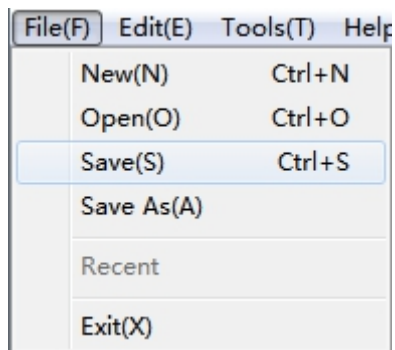

5.7 Auto Mapping

The mapping address of every command in the gateway must be calculated by fixed formula, users can use "Calculate Mapping Address" to calculate mapping address automatically.

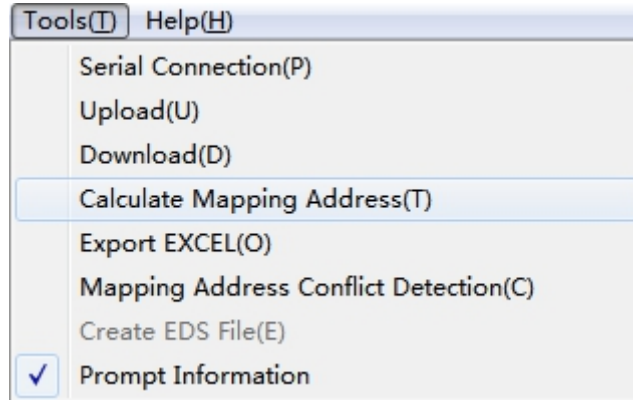

5.8 Export Excel File

Users can use the function to check the gateway configurations.

Select "Export EXCEL", you can save the configuration with .xls as its extension.

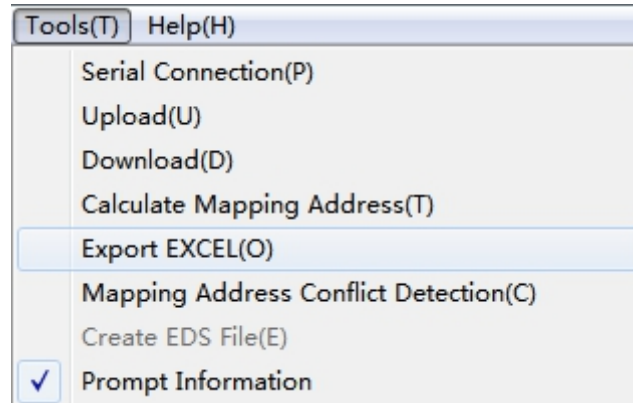

5.9 Monitor

When the first bit of DIP switch of GT200-DP-CO is set to "ON" status and the second bit is set to "OFF" status, GT200-DP-CO is in the debug mode.

This function can monitor the data in the input buffer of gateway memory. the interface is shown as below:

There are no data in the buffer and the interface is shown as below:

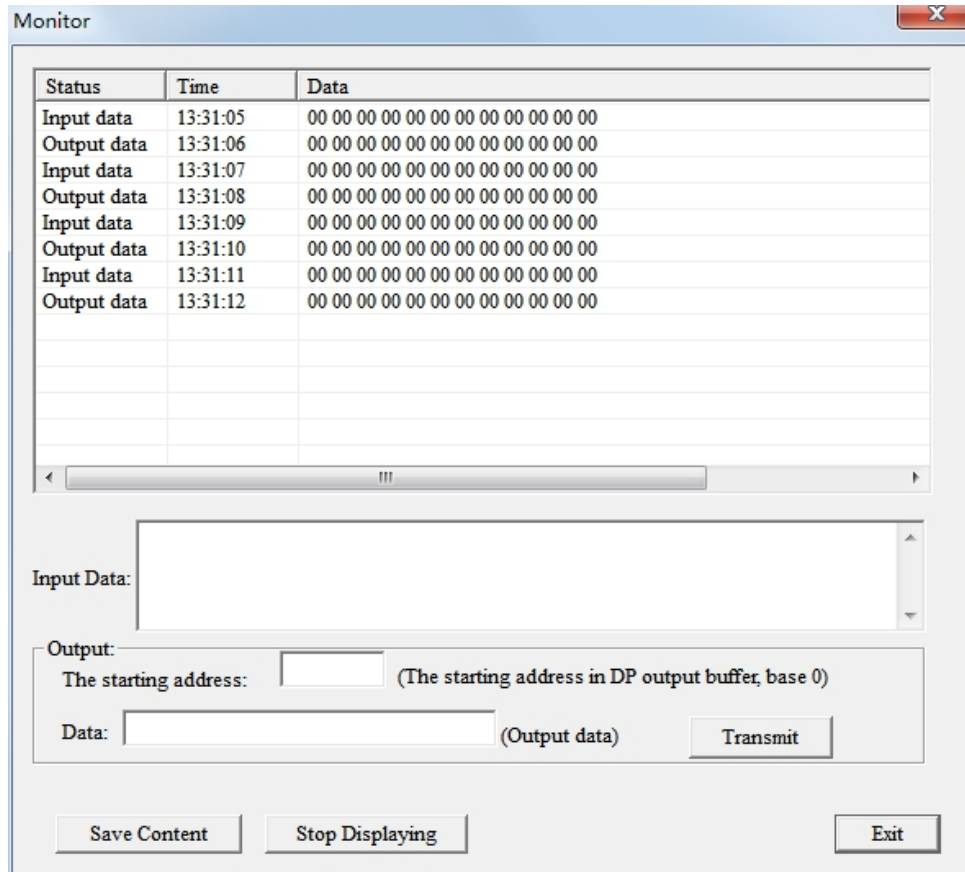

Users can click "Save content" button and save the data to disk of computer:

6 Working Principle

6.1 Data Exchange

6.1.1 Data Exchange as CANopen Master

Communication mode between CANopen and PROFIBUS DP is asynchronous mode, as shown below:

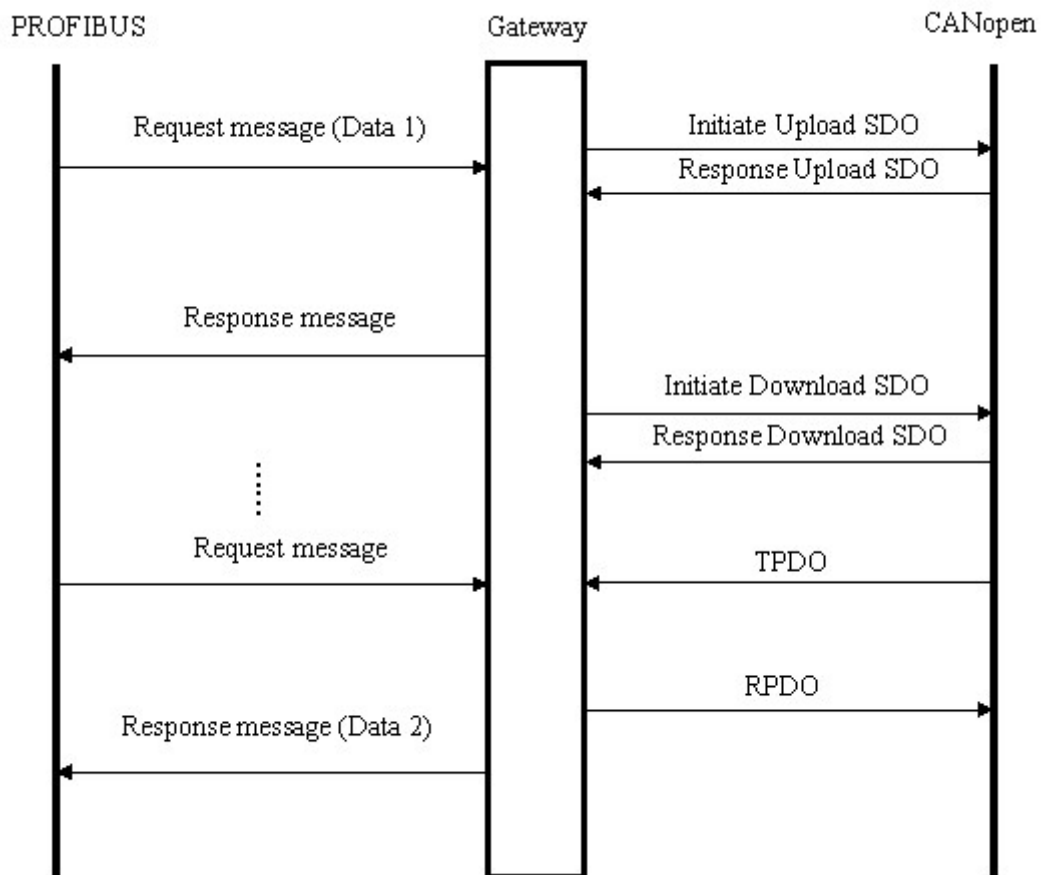

"Data 1" shows the data transfer process from PROFIBUS to CAN. "Data 2" shows the data transfer process from CAN to PROFIBUS.

The gateway runs in CANopen network independently, and transmits read/write commands of CANopen parameters periodically according object dictionary, also transmits and receives PDO commands. When receiving I/O request from PROFIBUS DP, the gateway will instantly respond with the latest CANopen data to realize the matching of network speed. This is asynchronous mode.

TPDO and RPDO applies producer/consumer mode, and often be used in the occasion with high requirement

about speed. Upload SDO and Download SDO applies client/server mode, the mode can guarantee safety of data, and often be used in the occasion with low requirement about speed.

The data in output buffer of GT200-DP-CO (PROFIBUS DP) is the data being mapped to RPDO or Download SDO commands of CANopen slave. Outputting mode of GT200-DP-CO is change of value, that is, until the DP output data is changed, GT200-DP-CO transmits corresponding commands (RPDO or Download SDO) to CANopen network. For DP input data, GT200-DP-CO receives data through TPDO or Upload SDO commands configured in the configuration software SST-CP-CFG and save the data to DP input buffer.

When the "Control&Status" bit is "Enable" in configuration software (SST-CP-CFG), there are two bytes in the end of input and output buffer of GT200-DP-CO showing status of CANopen slaves and controlling status of CANopen slave.

The last two bytes of input buffer (PROFIBUS DP) shows the status of CANopen slaves. The first byte of this two bytes is address of CANopen slave and the second byte is status of CANopen slave (i.e. pre-operational state, operational state, stop status, for detailed information, please refer to CANopen protocol). One time it only shows status of one CANopen slave, GT200-DP-CO applies FIFO mechanism to save all status of every CANopen slave and output to PROFIBUS DP master in FIFO order.

The last two bytes of output buffer (PROFIBUS DP) is the status that DP master controls CANopen slaves. The first byte of this two bytes is address of CANopen slave, the second byte is command controlling CANopen slave (i.e. go into pre-operational state, go into operational state, go into stop status, reset node, reset application and reset communication, for specific command format, please refer to NMT of CANopen protocol).

6.1.2 Data Exchange as CANopen Slave

Communication mode between CANopen and PROFIBUS DP is asynchronous mode, as shown below:

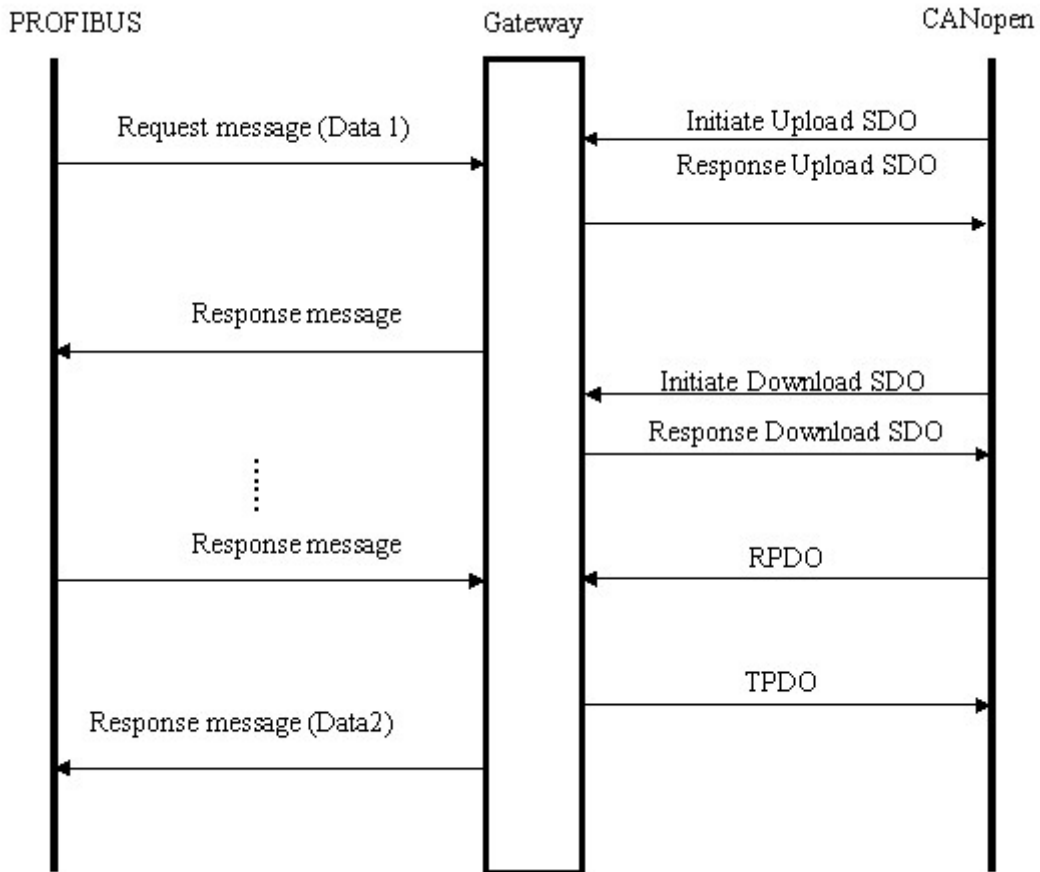

"Data 1" shows the data transfer process from PROFIBUS to CAN. "Data 2" shows the data transfer process from CAN to PROFIBUS.

The gateway runs in CANopen network independently, and transmits read/write commands of CANopen parameters periodically according object dictionary, also transmits and receives PDO commands. When receiving I/O request from PROFIBUS DP, the gateway will instantly respond with the latest CANopen data to realize the matching of network speed. This is asynchronous mode.

TPDO and RPDO applies producer/consumer mode, and often be used in the occasion with high requirement about speed. Upload SDO and Download SDO applies client/server mode, the mode can guarantee safety of data, and often be used in the occasion with low requirement about speed.

6.2 PROFIBUS DP Data Module

6.2.1 Acts as CANopen Master

The parameters the gateway provides are listed below:

Number	Input	Output Instance
1	112 bytes	112 bytes
2	96 bytes	96 bytes
3	48 bytes	48 bytes
4	16 bytes	16 bytes
5	Setting through Hardware Configuration of PROFIBUS DP	

Configure fixed input and output bytes in the software:

- The data module of length consistent GT200-DP-CO supports is listed below:

16 Byte In, 16 Byte Out: one 8 words Consistent

96 Byte In, 96 Byte Out: three 16 words Consistent

During Step7 programming, it needs to use package sending and receiving. Package sending and receiving mainly adopts SFC15 (package sending) and SFC14 (package receiving). (Please refer to chapter 5 for details)

- The data module of byte consistent GT200-DP-CO supports is listed below:

48 Byte In, 48 Byte Out

- The data module of word consistent GT200-DP-CO supports is listed below:

112 Byte In, 112 Byte Out

For the data module of byte and word consistent, users can use MOVE command to read/write data during Step7 programming.

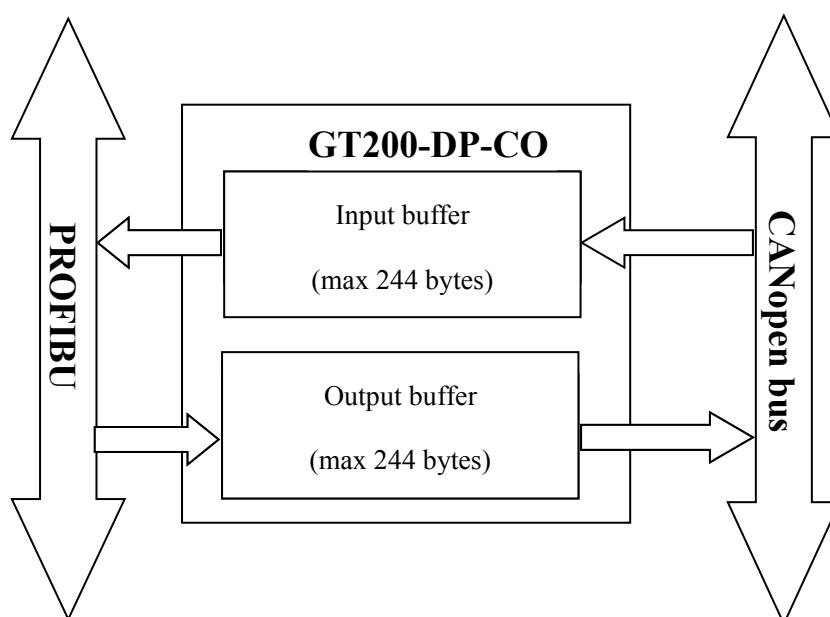

6.2.2 Acts as CANopen Slave

The parameters the gateway provides are listed below:

Number	Input	Output Instance
1	112 bytes	112 bytes
2	96 bytes	96 bytes
3	48 bytes	48 bytes
4	16 bytes	16 bytes
5	Setting through Hardware Configuration of PROFIBUS DP	

- The data module of length consistent GT200-DP-CO supports is listed below:
 16 Byte In, 16 Byte Out: one 8 words Consistent
 96 Byte In, 96 Byte Out: three 16 words Consistent
 During Step7 programming, it needs to use package sending and receiving. Package sending and receiving mainly adopts SFC15 (package sending) and SFC14 (package receiving). (Please refer to chapter 5 for details)
 - The data module of byte consistent GT200-DP-CO supports is listed below:
 48 Byte In, 48 Byte Out
 - The data module of word consistent GT200-DP-CO supports is listed below:
 112 Byte In, 112 Byte Out
- For the data module of byte and word consistent, users can use MOVE command to read/write data during Step7 programming.

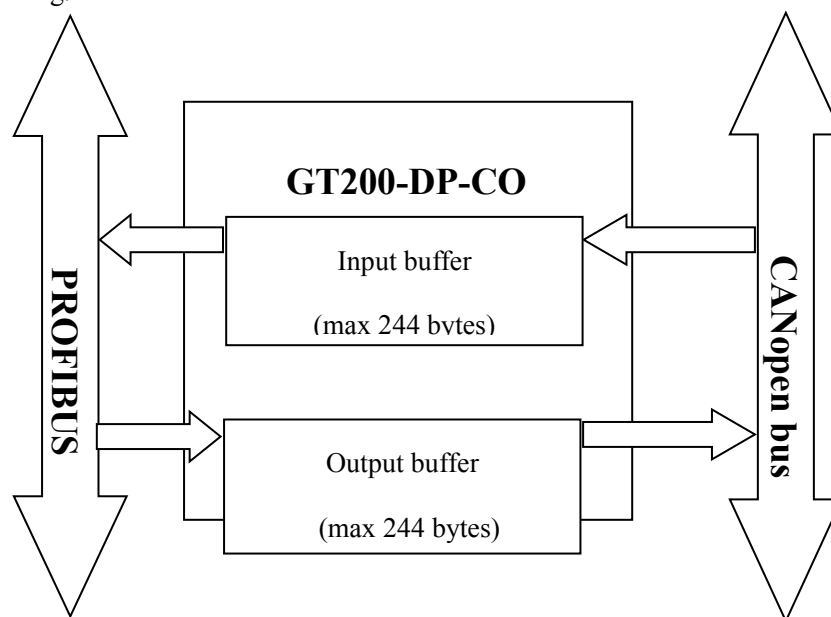

Input, output buffer support fast SDO visit, the location where input/output buffer is located in is listed below:

Index	Sub-index	Description
0x2000	00	Input No.0~No.3 byte of 224 bytes (4 bytes, writable)
0x2001	00	Input No.4~No.7 byte of 224 bytes (4 bytes, writable)
0x2002	00	Input No.8~No.11 byte of 224 bytes (4 bytes, writable)
0x2003	00	Input No.12~No.15 byte of 224 bytes (4 bytes, writable)
0x2004	00	Input No.16~No.19 byte of 224 bytes (4 bytes, writable)
0x2005	00	Input No.20~No.23 byte of 224 bytes (4 bytes, writable)
0x2006	00	Input No.24~No.27 byte of 224 bytes (4 bytes, writable)
⋮	⋮	⋮
0x2036	00	Input No.216~No.219 byte of 244 bytes (4 bytes, writable)
0x2037	00	Input No.220~No.223 byte of 244 bytes (4 bytes, writable)
0x2038	00	Input No.224~No.227 byte of 244 bytes (4 bytes, writable)
0x2039	00	Input No.228~No.231 byte of 244 bytes (4 bytes, writable)
0x203a	00	Input No.232~No.235 byte of 244 bytes (4 bytes, writable)
0x203b	00	Input No.236~No.239 byte of 244 bytes (4 bytes, writable)
0x203c	00	Input No.240~No.243 byte of 244 bytes (4 bytes, writable)

Index	Sub-index	Description
0x3000	00	Output No.0~No.3 byte of 244 bytes (4 bytes, readable)
0x3001	00	Output No.4~No.7 byte of 244 bytes (4 bytes, readable)
0x3002	00	Output No.8~No.11 byte of 244 bytes (4 bytes, readable)
0x3003	00	Output No.12~No.15 byte of 244 bytes (4 bytes, readable)
0x3004	00	Output No.16~No.19 byte of 244 bytes (4 bytes, readable)
0x3005	00	Output No.20~No.23 byte of 244 bytes (4 bytes, readable)
0x3006	00	Output No.24~No.27 byte of 244 bytes (4 bytes, readable)
⋮	⋮	⋮
0x3036	00	Output No.216~No.219 byte of 244 bytes (4 bytes, readable)
0x3037	00	Output No.220~No.223 byte of 244 bytes (4 bytes, readable)
0x3038	00	Output No.224~No.227 byte of 244 bytes (4 bytes, readable)
0x3039	00	Output No.228~No.231 byte of 244 bytes (4 bytes, readable)
0x303a	00	Output No.232~No.235 byte of 244 bytes (4 bytes, readable)
0x303b	00	Output No.236~No.239 byte of 244 bytes (4 bytes, readable)
0x303c	00	Output No.240~No.243 byte of 244 bytes (4 bytes, readable)

SDO read command (Upload SDO) request format

COBID=0x600+nodeID 8 bytes data 40 mm mm nn yy yy yy yy

Among them, 40 is fast read command, mm mm is index, nn is sub-index, yy yy yy yy is any value.



SDO read command response format

COBID=0x580+nodeID 8 bytes data 43 mm mm nn dd dd dd dd

Among them, 43 is the response of fast read command, mm mm is index, nn is sub-index, dd dd dd dd is the data read from output buffer.

For example: nodeID is 1, read output buffer index through SDO read command: 0x3000, sub-index: data of 00

Request: COBID=0x601 8 bytes data 40 00 30 00 yy yy yy yy

Response: COBID=0x581 8bytes data 43 00 30 00 01 02 03 04

Among them: 01 02 03 04 is the data read from output buffer.

SDO write command (Download SDO) format

COBID=0x600+nodeID 8 bytes data 23 mm mm nn dd dd dd dd

Among them, 23 is fast read command, mm mm is index, nn is sub index, dd dd dd dd is the data needs to be written to input buffer.

SDO write command format

COBID=0x580+nodeID 8 bytes data 60 mm mm nn 00 00 00 00

Among them, 60 is fast write response, mm mm is index, nn is sub index, 00 00 00 00 is default value.

For example, nodeID is 1, write data (01 02 03 04) to input buffer index through SDO write command: 0x2000, sub index: 00

Request: COBID=0x601 8 bytes data 23 00 20 00 01 02 03 04

Response: COBID=0x581 8bytes data 60 00 20 00 00 00 00 00

Among them: 01 02 03 04 is the data needs to be written to input buffer.

When CANopen side is slave, it supports visiting error register to estimate PROFIBUS communication state through SDO:

- SDO read command request format that CANopen master sent

COBID=0x600+nodeID 8bytes data 40 01 10 00 yy yy yy

Among them, 40 is fast read command, 0x1001 is index, 00 is sub index, yy yy yy yy is any value.

- SDO read command request format that CANopen slave sent:

COBID=0x580+nodeID 8 bytes data 4f 01 10 00 00 yy yy yy yy (00 means PROFIBUS is not off)

4f 01 10 00 80 yy yy yy yy (80 means PROFIBUS is off)

Among them, 4f is fast read command response, 0x1001 is index, 00 is sub index, yy yy yy is any value.

6.3 How Step7 Reads and Writes Gateway Data

When you choose "Setting through Hardware Configuration of PROFIBUS DP" in the configuration software SST-CP-CFG, you must refer to this chapter. GT200-DP-CO provides new modules shown as below. The maximum allowed number of modules is 64 in Step7. The maximum allowed number of input bytes is 244, the max number of output bytes is 244 and the aggregate of maximum number of input bytes and output bytes is 488.

Module	Integrity
4 Words Input, 4 Words Output	Word
8 Words Input, 8 Words Output	Word
24 Words Input, 24 Words Output	Word
56 Words Input, 56 Words Output	Word
1 Byte Input	Byte
1 Word Input	Word
2 Words Input	Word
4 Words Input	Word
8 Words Input	Word
16 Words Input	Word
32 Words Input	Word
64 Words Input	Word
2 Words Input Consistency	length
4 Words Input Consistency	length
8 Words Input Consistency	length
16 Words Input Consistency	length
1 Byte Output	Byte
1 Word Output	Word
2 Words Output	Word
4 Words Output	Word
8 Words Output	Word
16 Words Output	Word
32 Words Output	Word
64 Words Output	Word
2 Words Output Consistency	Total length
4 Words Output Consistency	Total length
8 Words Output Consistency	Total length
16 Words Output Consistency	Total length

As is shown above, the data modules which GT200-DP-CO supports include: Word integrity, Byte integrity and length integrity.

For the data modules that support Word and Byte integrity, you can use command "MOVE" to access the data during STEP7 programming.

For the data modules that support length integrity, user can take compression way to send and receive data. The compression way mainly uses "SFC 15" when sending and receiving uses "SFC 14":

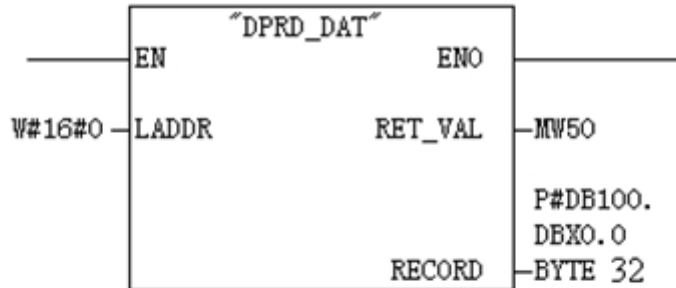

SFC14 (compressing sending)

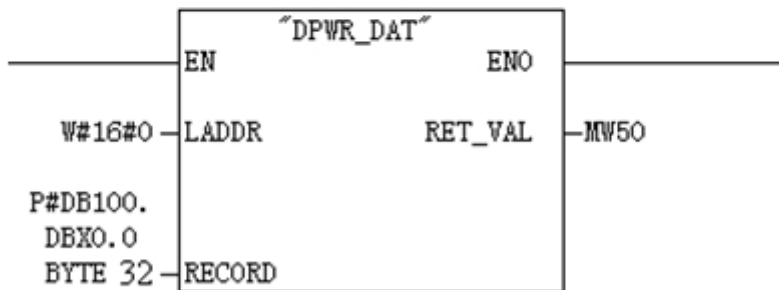

SFC15 (compressing receiving)

6.4 How Step7 Selects Data Module

Generally, when the data modules include "Consistent", this means this data module is length integrity. When accessing data, you need to use SFC14 (read) and SFC15 (write) to read or write data. And those which didn't include "Consistent", you can use "Move" command to access the data.

According to user's demand of input/output bytes, there are so many alternatives for the selection of data modules. For example: When user needs 20-words input (The data number reading form Modbus slave through PLC is 20 words), user can directly select data modules no less than 20 words input (32words Input、64words Input...) or input one input/output modules no less than 20 words (56 words Input, 56words Output...).

Take "2 words Input Consistent" as an example, when you choose the module, you must use "SFC 14" to access the data address. When some data of Modbus slave is two-word data, and needs high accuracy and real-time, user generally select "2 words Input Consistent", and not to select "2 words Input". So, PLC can access the whole data module during reading data, and it can also prevent data from burst changing (last word data and next word data are not read in the same time) and causing incorrect data.



Appendix: Using STEP7 to Set PROFIBUS DP Communication

The following show how to use STEP7 to configure GT200-DP-CO:

First of all, copy *.gsd file to the following path: *Step7\S7data\gsd*

1. Open SIMATIC Manager  . Figure 1:

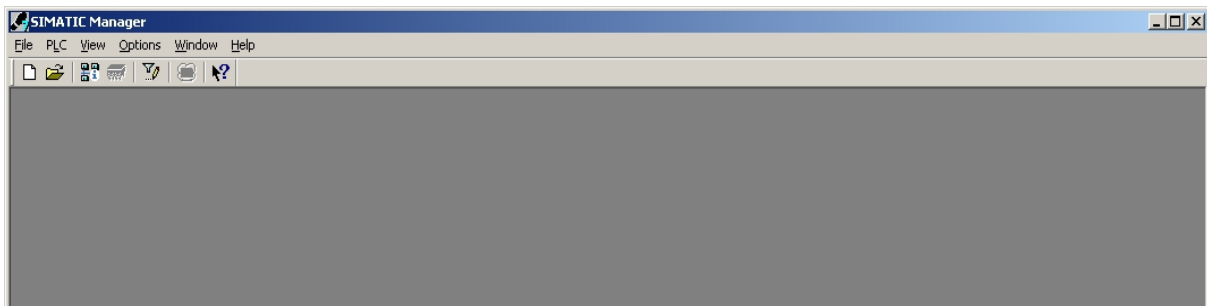

Figure 1

2. Click File->New, create a new project. Figure 2:

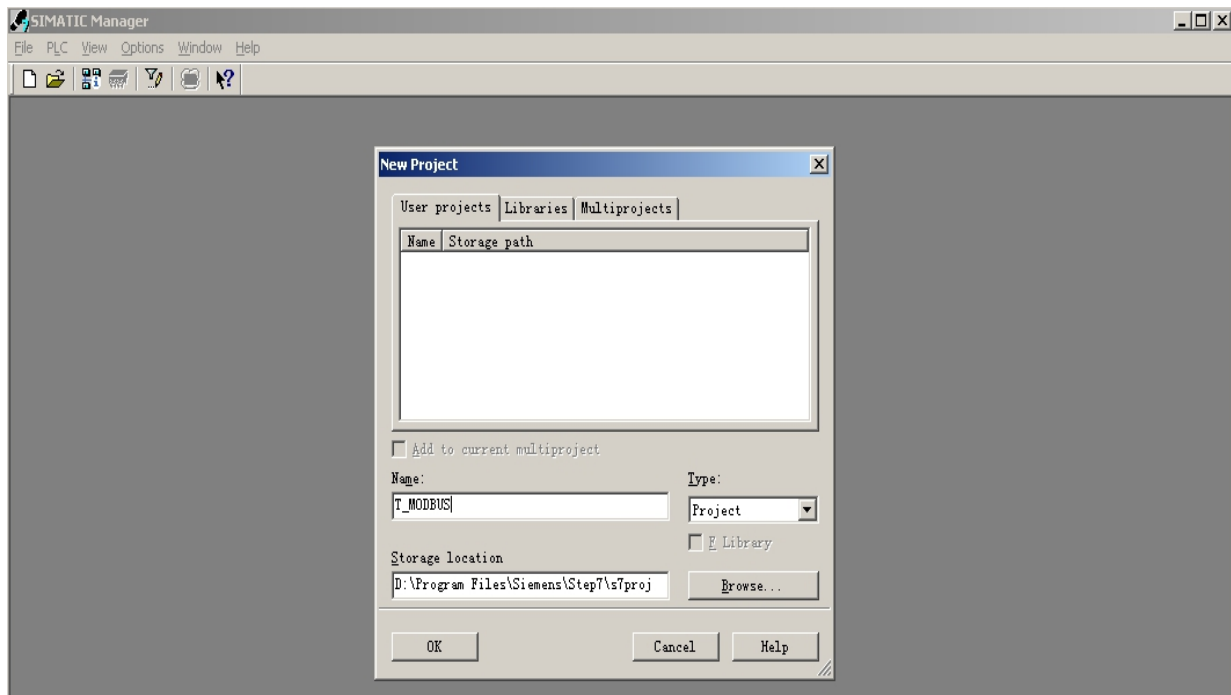

Figure 2

3. Insert->Station->SIMATIC 300 Station. Figure3:

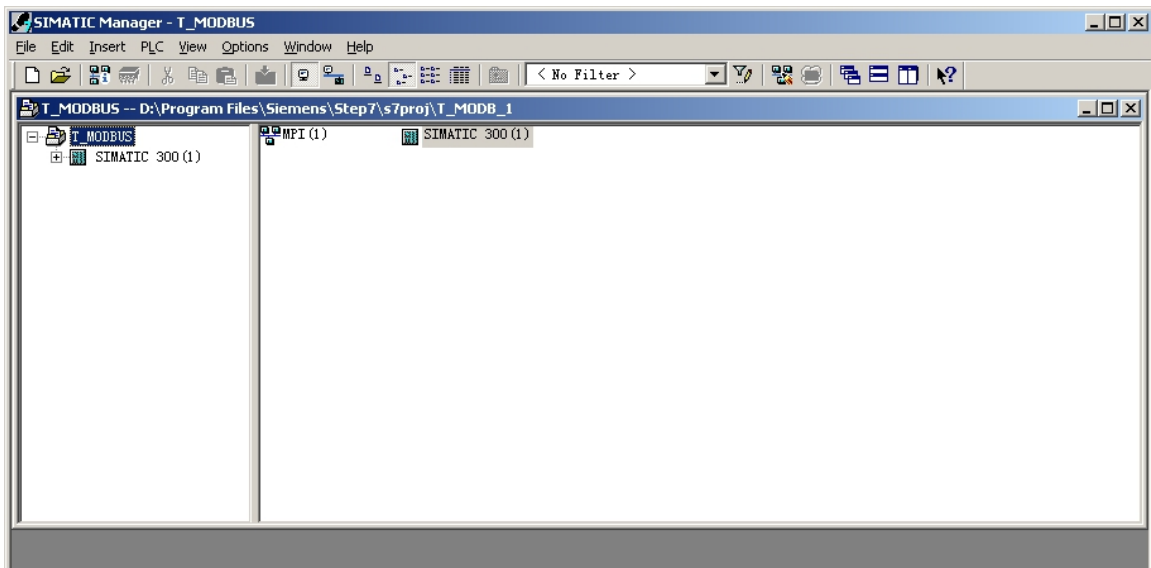

Figure 3

4. Open S7 PLC hardware configuration: SIMATIC 300(1)->Hardware, double-click. Figure 4:

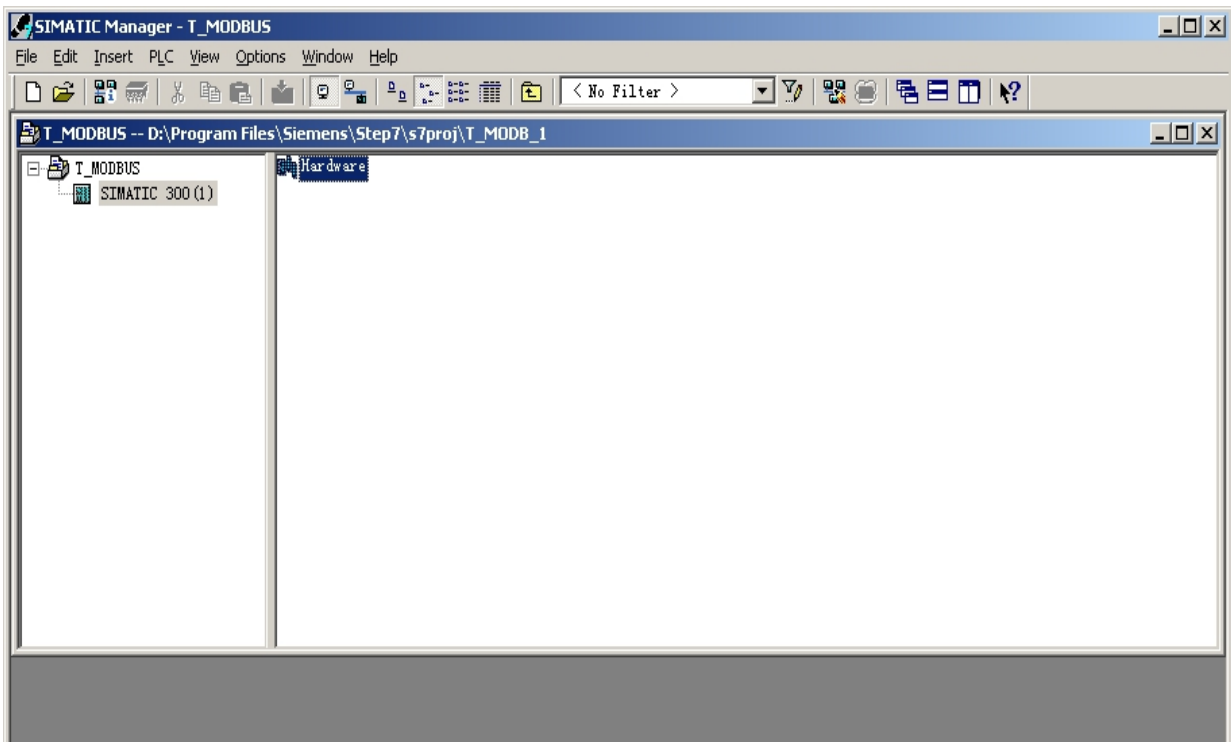

Figure 4

GT200-DP-CO CANopen/PROFIBUS DP Gateway User Manual

5. Click Option->Update Catalog, update GSD in device catalog.

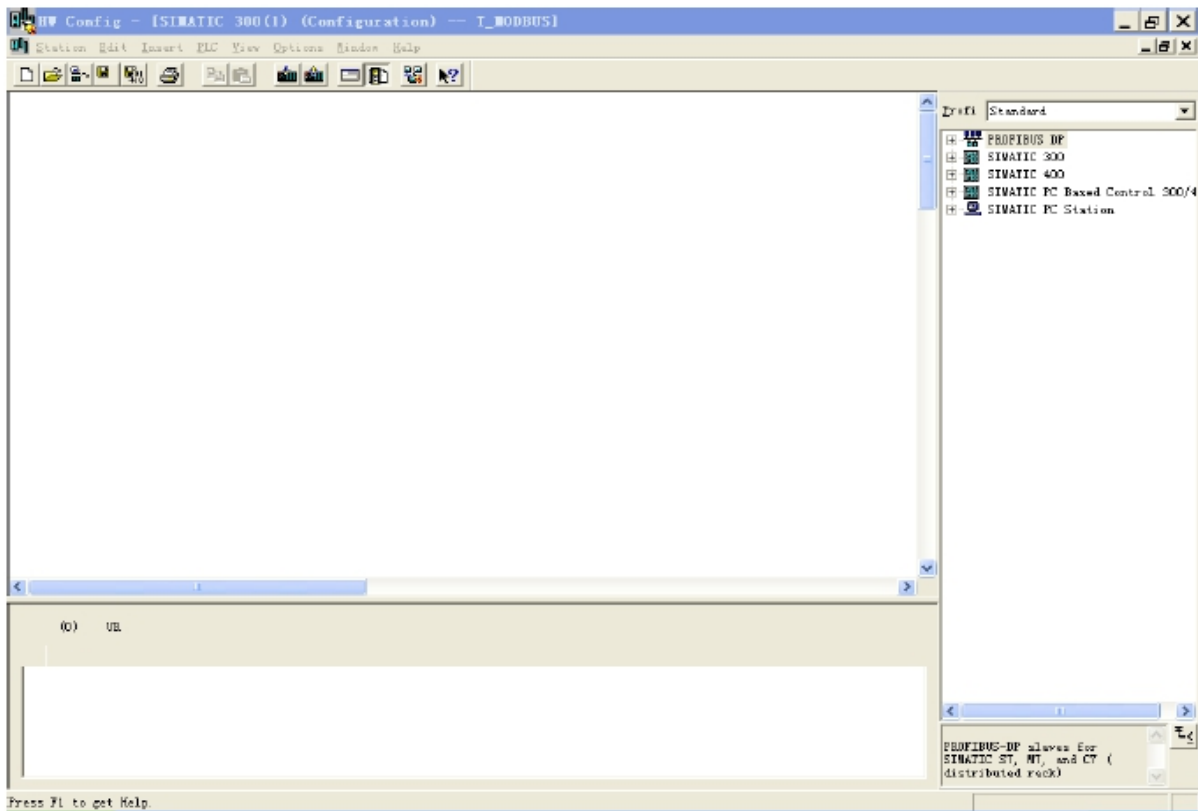

Figure 5

6. Here you can find your equipment in the right side of the window. Figure 6

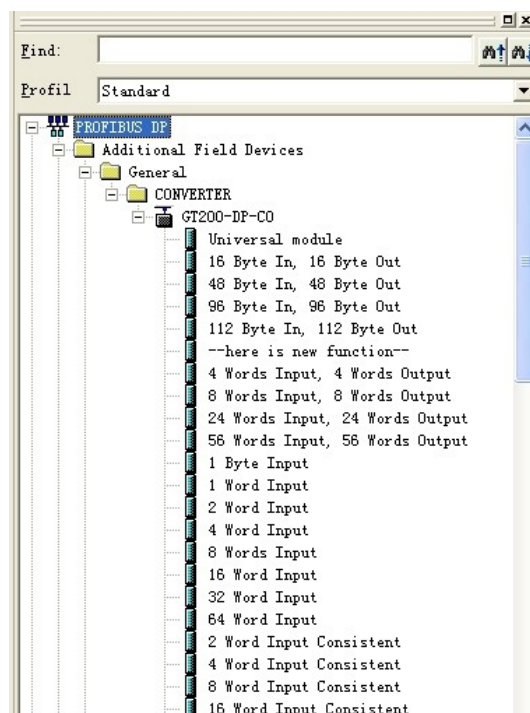

Figure 6

GT200-DP-CO CANopen/PROFIBUS DP Gateway User Manual

7. Set PLC rack, click the "Hardware Catalog \ SIMATIC 300 \ RACK-300 \ Rail". Figure 7:

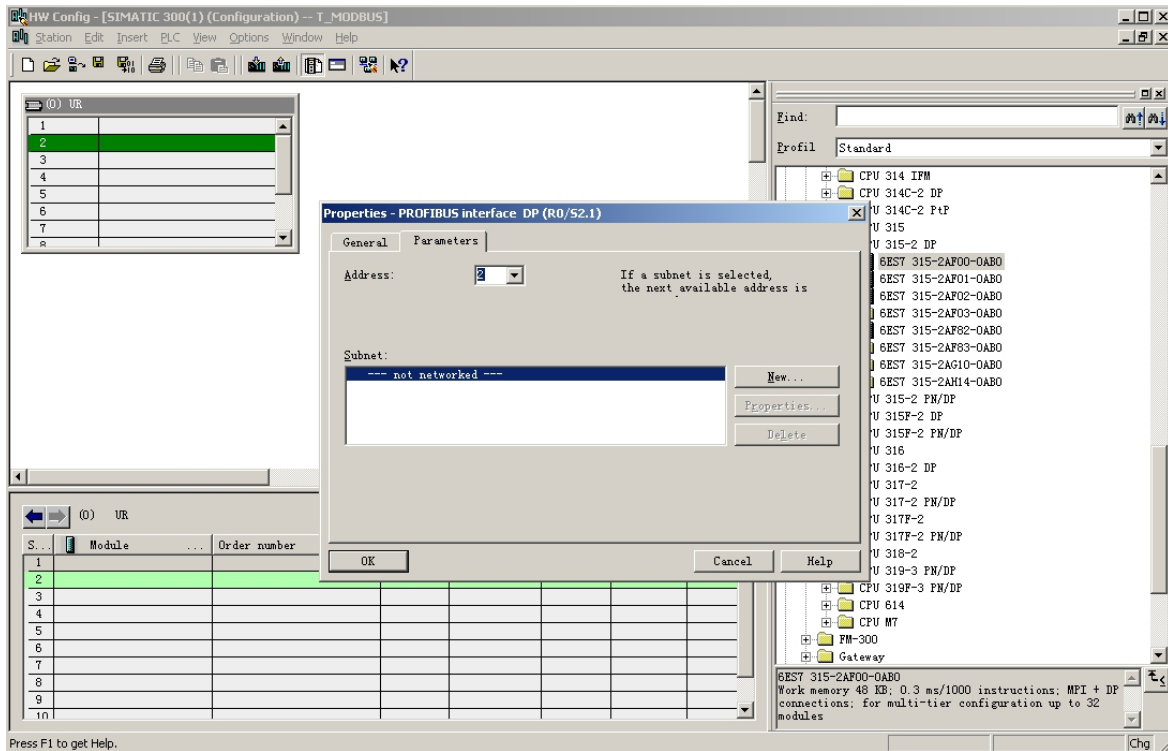

Figure 7

8. Set CPU module and select the corresponding device type and the occupied slots.

9. Create PROFIBUS DP network and set up PROFIBUS DP: Click New and then Network settings, select DP. select a baud rate such as 187.5Kbps, then "OK". Double-click it. Figure 8:

GT200-DP-CO CANopen/PROFIBUS DP Gateway User Manual

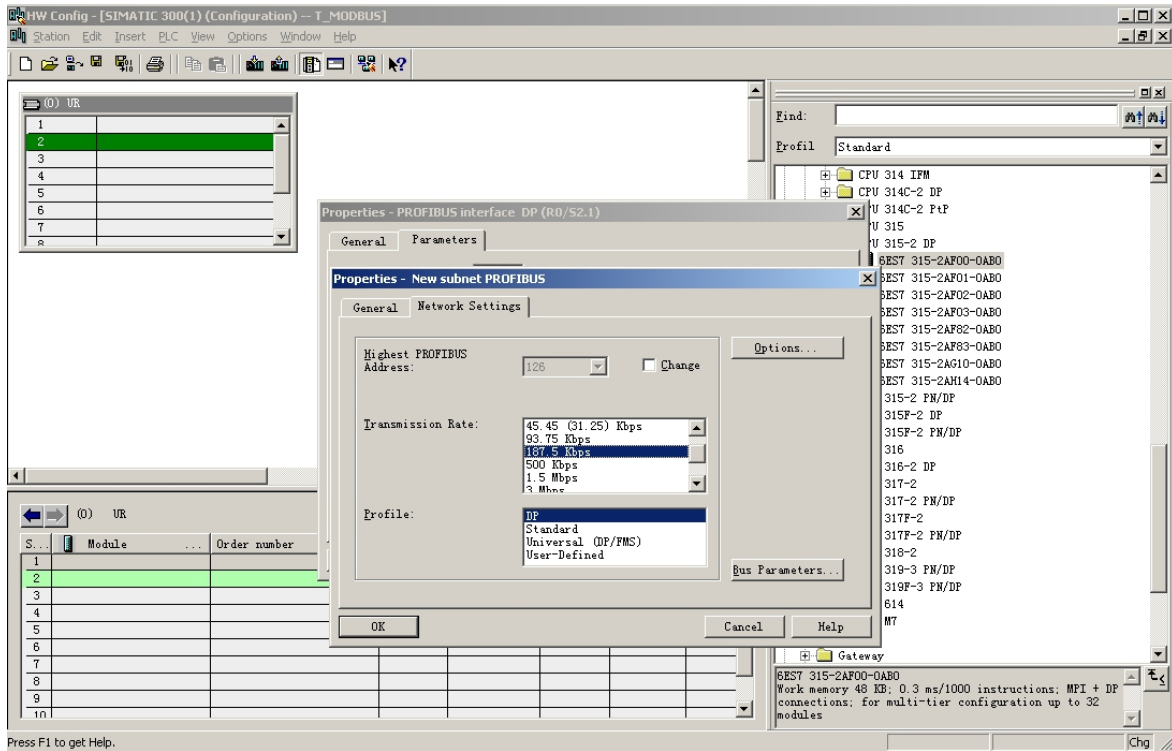

Figure 8

10. Select PROFIBUS Master station address, Figure 9:

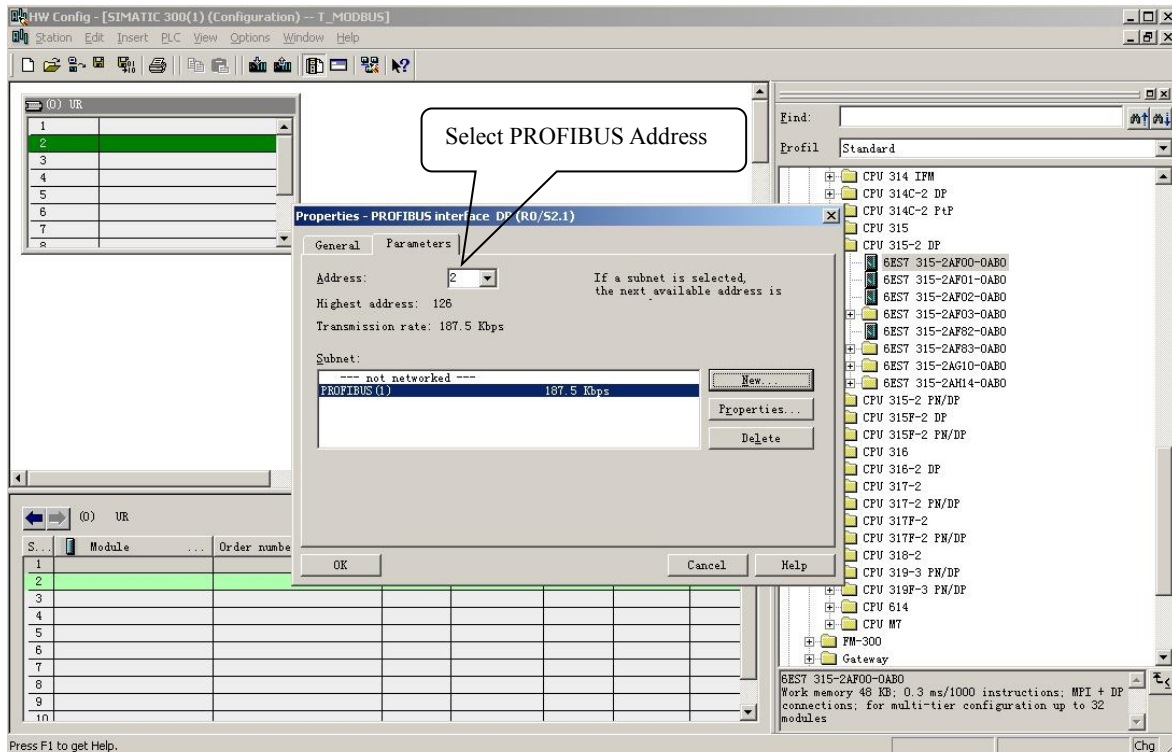

Figure 9

GT200-DP-CO CANopen/PROFIBUS DP Gateway User Manual

11. Drag GT200-DP-CO to PROFIBUS DP network bus, and drag data modules to slots, that is mapping the input and output data module into master controller's memory. Figure 10:

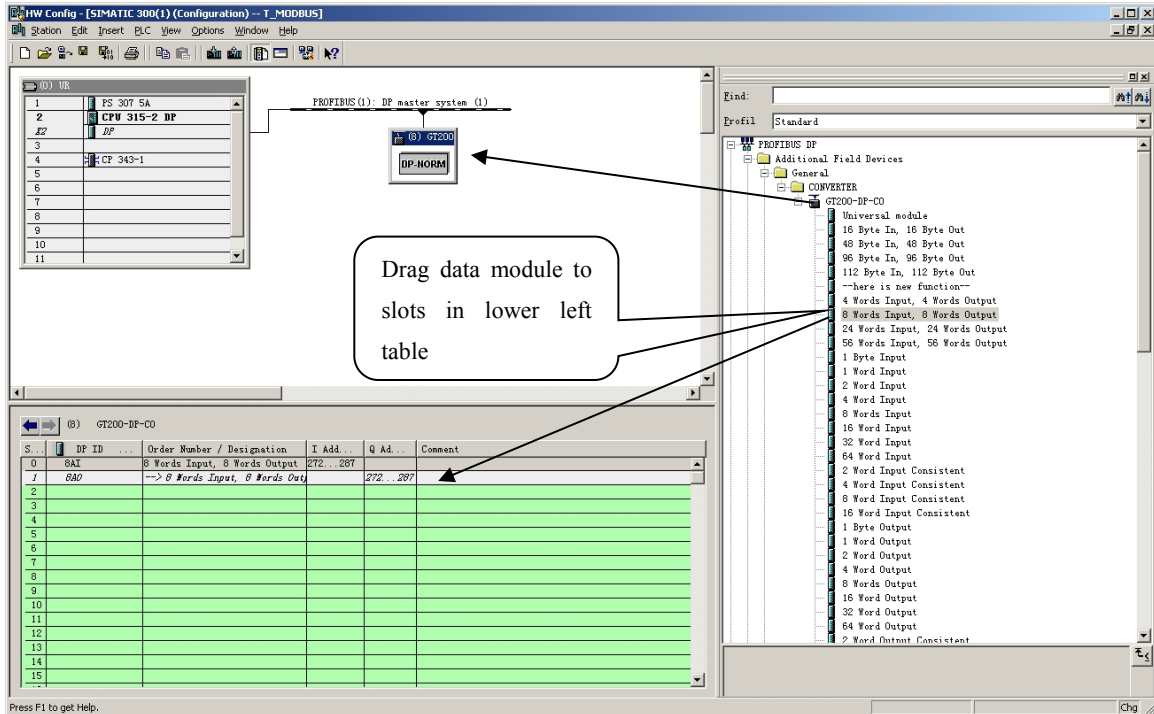

Figure 10

Operation is divided into two steps, the first step is dragging GT200-DP-CO to PROFIBUS DP network bus, the mouse will change shape, and that is to say, it can be placed. The second step is dragging data module into master controller's memory.

Note 1: Users configure input and output bytes of GT200-DP-CO through configuration software SST-CP-CFG. If users select 48, and then drag "48 Byte In, 48 Byte Out" to the slots. The default is "112 Byte In, 112 Byte Out".

Note 2: The PROFIBUS DP slave address must be in line with the settings of module DIP switch!

12. Compile and download into PLC.